



**Hantek**



**HBT4000** series

Internal resistance tester

Quick Guide

2023.12

## **Warranties and Declarations**

### **Copyright**

The copyright of this document belongs to Qingdao Hantek Electronic Co., LTD.

### **Statement**

Qingdao Hantek Electronic Co., Ltd. reserves the right to amend this document without prior notice. Qingdao Hantek Electronic Co., Ltd. promises that the information provided is correct and reliable but does not guarantee that this document is free from errors. Before using this product, please make sure that the specifications of relevant technical documents are the latest effective version. If you use documents or products of Qingdao Hantek Electronic Co., LTD and need products, patents or works of third parties to cooperate with them, you shall be responsible for obtaining the consent and authorization of the third parties. The above consent and authorization shall not be the liability of Hantek.

### **Product certification**

The Hantek certified HBT4000 series internal resistance tester meets Chinese national and industry standards, and has passed CE certification and UKCA certification.

### **Contact Us**

If you have any questions or uncertainties while using the products of Qingdao Hantek Electronics Co., Ltd., you can obtain service and support through the following methods:

Email: [service@hantek.com](mailto:service@hantek.com) , [support@hantek.com](mailto:support@hantek.com)

Website: <http://www.hantek.com>

# 1 Safety requirement

## 1.1 Summary of general security issues

Read the following safety precautions carefully to avoid injury and to prevent damage to this product or any product connected. To avoid possible dangers, please use this product in accordance with the regulations.

- **Only professionally authorized personnel can perform repairs.**
- **Use the correct power cord.**

Only use the dedicated power cord recognized by the country where the product is located.

- **Ground the product.**

To avoid electric shocks, the product is grounded through a grounding conductor of the power cable. The grounding conductor must be connected to the ground before connecting the input or output terminals of the product. Ensure that the product is properly grounded.

- **View all terminal rating values.**

To avoid fire or excessive current, please check all rating values and signs on the product. Please consult the product manual for details of the rating values before connecting the product.

- **Do not operate with the cover open.**

Do not run the product with the cover or panel open.

- **Avoid circuit exposure.**

Do not touch exposed connectors and components after power is switched on.

- **Do not operate if the product is suspected to be faulty.**

If you suspect that the product has been damaged, please ask qualified maintenance personnel to check it.

- **Maintain proper ventilation.**
- **Do not operate in a humid environment.**
- **Do not operate in inflammable or explosive environment.**
- **Please keep the product surface clean and dry.**



### **Warning:**

**Equipment that meets Class A requirements may not provide adequate protection for broadcast services in residential environments.**

## 1.2 Security terms and signs

### Security terms in this manual:



#### Warning:

Indicates that the operation may not cause immediate damage to you.



#### Warning:

Indicates that if you perform this operation, it may not immediately cause damage to you.



#### Note:

Indicates that the operation may cause damage to the product or other property.

### Safety terms on products:

#### Warning:

Indicates a potential hazard may be caused to you if you do not perform this operation.

### Safety signs on the product:



Warning



Shell grounding  
terminal



Environmental protection  
usage period  
identification

## 1.3 Measurement category

### Measurement category

This instrument can be used for measurement under class I.



#### Warning:

**This instrument is only allowed to be used in the specified measurement class.**

### Measurement class definition

- **Class I** refers to measurements taken on a circuit not directly connected to the main power supply. For example, measurements made on circuits that are not exported from a main power supply, especially from a protected (internal) main power supply. In the latter case, the instantaneous stress will change. Therefore, the user should understand the instantaneous capacity of the instrument.
- **Class II** refers to measurements taken on a circuit directly connected to low-voltage instruments. For example, measurements made on household appliances, portable tools, and similar equipment.
- **Class III** refers to measurements taken on construction equipment. For example, measurements made on switchboards, circuit breakers, circuits (including cables, busbars, junction boxes, switches, sockets) in fixed equipment, as well as equipment for industrial use and certain other equipment (for example, fixed motors permanently connected to fixed instruments).
- **Class IV** refers to measurements taken at the source of low-voltage equipment. For example, measurements made on electricity meters, primary overcurrent protection equipment, and pulse control units.

## 1.4 Ventilation Requirement

---

To ensure sufficient ventilation, when using the instrument in a workbench or rack, please ensure that there is a gap of at least 10 centimeters on both sides, above, and behind it.



**Note:**

Poor ventilation can cause an increase in instrument temperature, leading to instrument damage. Good ventilation should be maintained during use, and ventilation openings should be regularly checked.

## 1.5 Work Environment

---

**Operating temperature and humidity range**

0 °C -40 °C, below 80% RH (without condensation)

**Storage temperature and humidity range**

-10 °C -50 °C, below 80% RH (without condensation)

**Accuracy assurance temperature and humidity range**

23 °C ± 5 °C, below 80% RH (without condensation)

**Warning:**



**To avoid the risk of short circuits or electric shock inside the instrument, do not operate the instrument in a damp environment.**

#### **Altitude**

Operating and Non-operating: 2,000m.

**This product is powered by mains conforming to installation (overvoltage) category II.**



#### **Warning:**

Ensure that no overvoltage (e.g. from lightning) reaches the product. Otherwise, the operator may be in danger of receiving electric shock.

#### **Installation (Overvoltage) Category Definitions.**

**Installation (overvoltage) category I** refers to the signal level, which is suitable for measuring terminals connected to equipment in the source circuit, where measures have been taken to limit instantaneous voltage to the corresponding low level.

**Installation (overvoltage) category II** refers to the local distribution level, which is suitable for equipment connected to the mains (AC power supply).

#### **Pollution Degree**

Pollution Degree 2

#### **Pollution Degree Definition**

- **Pollution Degree 1:** No pollution or only dry, nonconductive pollution occurs. The pollution has no effect. For example, a clean room or air-conditioned office environment.
- **Pollution Degree 2:** Normally only nonconductive pollution occurs. Temporary conductivity caused by condensation is to be expected. For example, indoor environment.
- **Pollution Degree 3:** Conductive pollution or dry nonconductive pollution that becomes conductive due to condensation occurs. To be found in industrial environment or construction sites (harsh environments). For example, sheltered outdoor environment.
- **Pollution Degree 4:** The pollution generates persistent conductivity caused by conductive dust, rain, or snow. For example, outdoor areas.

#### **Security level**

Class 1 - Grounded products

## 1.6 Care and Cleaning

---

### Care:

When storing or placing the internal resistance tester, do not expose the LCD display to direct sunlight for a long time.

### Cleaning:

According to the requirements of operating conditions, regularly check the internal resistance tester and test line. Please clean the outer surface of the instrument according to the following steps:

- 1) Use a lint free cloth to remove floating dust from the outside of the internal resistance tester and test line. Please be extremely careful to avoid scratching the smooth display filter material.
- 2) Clean the internal resistance tester with a soft cloth soaked in water. To clean more thoroughly, a water solvent of 75% isopropanol can be used.



### Note:

To avoid damaging the surface of the internal resistance tester or test line, do not use any corrosive or chemical cleaning agents.



### Warning:

Before re powering on, please confirm that the instrument has dried thoroughly to avoid electrical short circuits or even personal injury caused by moisture.

## 1.7 Environmental precautions

---

The following symbols indicate that this product complies with the requirements established by WEEE Directive 2002/96/EC.



### Equipment recycling:

The production of this equipment requires the extraction and utilization of natural resources. If the scrapping of this product is not handled properly, certain substances contained in the equipment may be harmful to the environment or human health. To avoid the release of harmful substances into the environment and reduce the use of natural resources, it is recommended to use appropriate methods to recycle this product to ensure that most materials can be correctly reused.



## 2 Overview

This document is used to guide users to quickly understand the front and rear panels, user interface, and basic operating methods of the HBT4000 series internal resistance tester.



### Tip:

The latest version of this manual can be downloaded at <http://www.hantek.com>.

**Document number: 202312**

### Software version:

Software upgrade may change or increase product functionalities, please pay attention to Hantek website for the latest version.

### Document format conventions:

#### 1 button

Use "square brackets+text (bold)" to represent the front panel buttons, for example, **[Utility]** represents the "Utility" button.





#### 2 menus

Use "menu text (bold)+blue" to represent a menu option, such as "**other**" to click on the "other" option on the current operating interface of the instrument and enter the "other" function configuration menu.

#### 3 Operation steps

Use "->" to represent the next step. For example, **[Utility]** -> **Other** means click Utility label before clicking Other menu.

#### 4 Button icon

Icon	Button	Icon	Button
	Direction keys		Screenshot key
	Confirm key		Menu softkeys

### Document content agreement:

The HBT4000 series internal resistance tester includes the following models. Unless otherwise specified, this manual uses HBT4563H as an example to explain the HBT4000 series and its basic operations.



Model	Resistance resolution	Voltage resolution	Measuring range	Interface
HBT4561A	0.1 $\mu\Omega$	1 $\mu\text{V}$	0~3.9k $\Omega$ / 0~160V	RS232/485,USB,LAN,I O,ANALOG OUTPUT
HBT4561H	0.1 $\mu\Omega$	1 $\mu\text{V}$	0~3.9k $\Omega$ / 0~160V	RS232/485,USB,LAN,I O,ANALOG OUTPUT,GPIB
HBT4562A	0.1 $\mu\Omega$	1 $\mu\text{V}$	0~3.9k $\Omega$ / 0~260V	RS232/485,USB,LAN,I O,ANALOG OUTPUT
HBT4562H	0.1 $\mu\Omega$	1 $\mu\text{V}$	0~3.9k $\Omega$ / 0~260V	RS232/485,USB,LAN,I O,ANALOG OUTPUT,GPIB
HBT4563A	0.1 $\mu\Omega$	1 $\mu\text{V}$	0~3.9k $\Omega$ / 0~410V	RS232/485,USB,LAN,I O,ANALOG OUTPUT
HBT4563H	0.1 $\mu\Omega$	1 $\mu\text{V}$	0~3.9k $\Omega$ / 0~410V	RS232/485,USB,LAN,I O,ANALOG OUTPUT,GPIB
HBT4564A	0.1 $\mu\Omega$	10 $\mu\text{V}$	0~3.9k $\Omega$ / 0~1300V	RS232/485,USB,LAN,I O,ANALOG OUTPUT
HBT4564H	0.1 $\mu\Omega$	10 $\mu\text{V}$	0~3.9k $\Omega$ / 0~1300V	RS232/485,USB,LAN,I O,ANALOG OUTPUT,GPIB

Model	Resistance resolution	Voltage resolution	Measuring range	Interface
HBT4565A	0.1 $\mu\Omega$	10 $\mu\text{V}$	0~3.9k $\Omega$ / 0~1700V	RS232/485,USB,LAN,I O,ANALOG OUTPUT
HBT4565H	0.1 $\mu\Omega$	10 $\mu\text{V}$	0~3.9k $\Omega$ / 0~1700V	RS232/485,USB,LAN,I O,ANALOG OUTPUT,GPIB
HBT4566A	0.1 $\mu\Omega$	10 $\mu\text{V}$	0~3.9k $\Omega$ / 0~2100V	RS232/485,USB,LAN,I O,ANALOG OUTPUT
HBT4566H	0.1 $\mu\Omega$	10 $\mu\text{V}$	0~3.9k $\Omega$ / 0~2100V	RS232/485,USB,LAN,I O,ANALOG OUTPUT,GPIB

## 3 **General inspection**

---

### **Check transportation packaging**

After receiving the internal resistance tester, the user should check the equipment according to the following steps: check whether there is any damage caused by transportation: if the packaging carton or foam plastic protective pad is seriously damaged, please keep it until the whole machine and accessories pass the electrical and mechanical tests.

### **Check attachments**

The details of the provided attachments are explained in Appendix A: Models and Accessories at the end of this manual. If missing or damaged attachments are found, please contact the dealer responsible for this business.

### **Inspect the entire machine**

If you find that the appearance of the instrument is damaged, the instrument is not working properly, or it fails the performance test, please contact the dealer responsible for this business.

## 4 Product Introduction

The HBT4000 series internal resistance tester is a battery internal resistance tester with high precision, high resolution, and fast measurement characteristics. Using the AC four terminal testing method to more accurately test the internal resistance and voltage of the battery;  $0.1\mu\Omega$  Resistance resolution, minimum voltage resolution  $1\mu\text{V}$ . Ensure the credibility of the measurement; Built in comparator function to automatically determine whether battery parameters meet standards; Built in multiple high-speed communication interfaces, suitable for more testing scenarios; Easy to operate, precise and fast, stable and reliable, this battery internal resistance tester will be your best choice.

### 4.1 Introduction to Front Panel

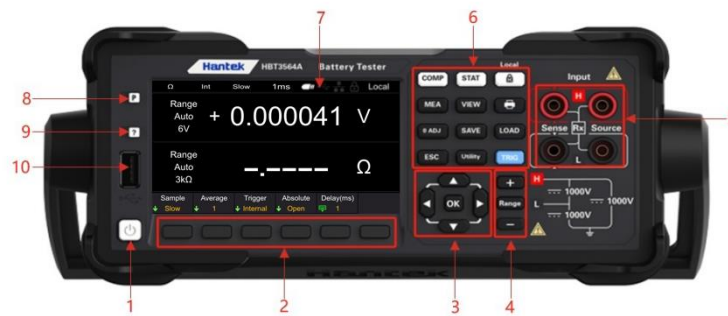

- |  |  |
|--|--|
| 1 Key switch   | 2 Menu soft keys                           |
| 3 Directional keys<br>(up/down/left/right), confirm<br>key | 4 Plus keys, range keys, and minus<br>keys |
| 5 Input ports  | 6 Function keys                            |
| 7 LCD display screen                                       | 8 Restore default settings                 |
| 9 Help   | 10 USB HOST interface                      |

## 4.2 Introduction to Rear Panel

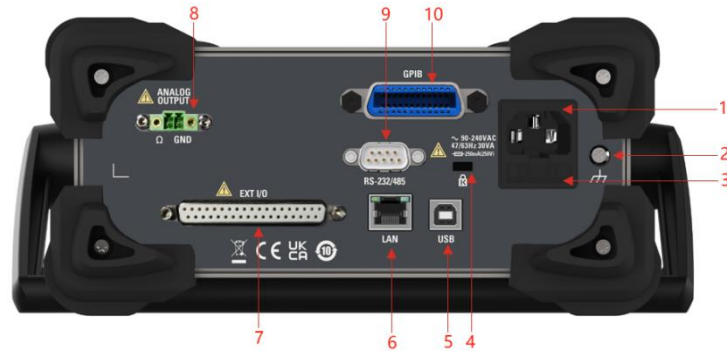

1 AC power socket

2 Shell grounding terminal

3 Fuse holder

4 Safety lock holes

5 USB DEVICE interface

6 LAN interface

7 EXT I/O interface

8 ANALOG OUTPUT interface

9 RS-232/485 interface

10 GPIB interface

## 4.3 User Interface Introduction

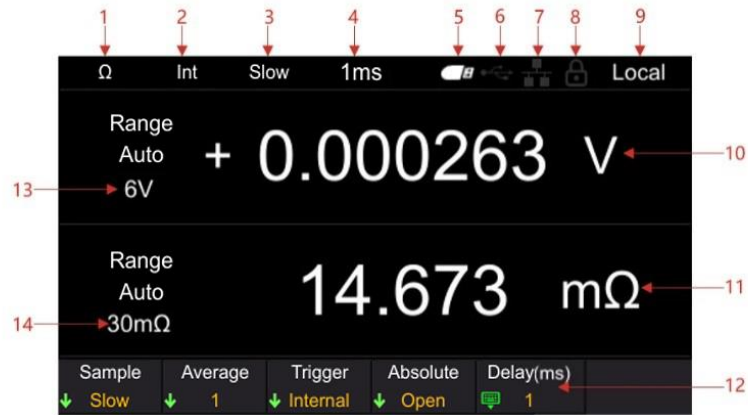

- |                                 |                               |
|---------------------------------|-------------------------------|
| 1 Range Quick Identification    | 2 Trigger sources             |
| 3 Sampling rates                | 4 Delay                       |
| 5 USB icon display              | 6 USB device icon display     |
| 7 Network icon display          | 8 lock screen icons           |
| 9 Local/Remote Display          | 10 Voltage measurement values |
| 11 Resistance measurement value | 12 Auxiliary menu bar         |
| 13 Resistance range             | 14 Voltage range              |

## 5 Preparation before use

### 5.1 Connecting the power supply

This series of internal resistance testers can input AC power with specifications of 90-240 VAC, 47/63Hz, and 30VA. Please connect the internal resistance tester to the power supply using the power cord provided in the attachment. Press the power switch in the lower left corner of the front panel to turn on the instrument. If the instrument is not turned on, please confirm that the power cord is securely connected and ensure that the instrument is connected to a powered power source.

**Warning:**



To avoid electric shock, please ensure that the instrument is properly grounded.

### 5.2 Adjusting the handle

To adjust the handle of the instrument, hold the handles on both sides of the instrument and pull them outward, then rotate the handles.

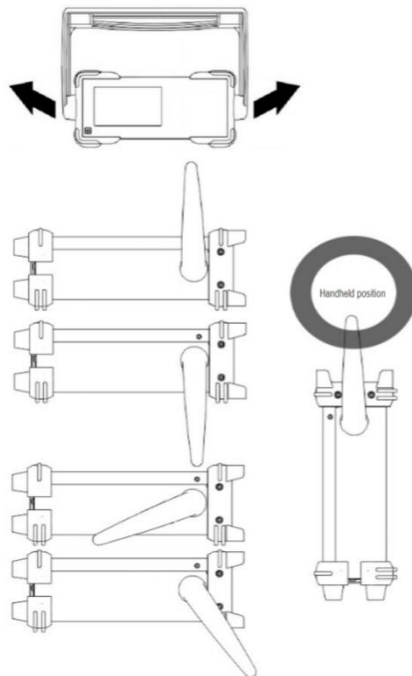



## 5.3 Setting System Language

The internal resistance tester supports both Chinese and English menus, and provides corresponding help information, prompt information, and interface display.

Press [**Utility**] -> **Other** -> **English** to select the desired language. When selecting "Chinese" or "English", the menu, help information, prompt messages, and interface are displayed in Chinese or English, respectively.

## 6 Using the built-in help system

To obtain help information for any front panel buttons or menu soft keys, on the measurement display interface, press the [?] button on the front panel, and then press the button you need help with to obtain the operation prompt for that button. Press the [?] button again to exit the help system.

## 7 Set parameter values

The parameter settings of this series of internal resistance testers support numeric keyboard input. Parameter settings can be completed by left clicking, right clicking, and confirmation keys. Move the cursor position by clicking the left and right buttons, and click the confirm button **[OK]** to input. Move the cursor to the enter key , then click **[OK]** to save and exit.

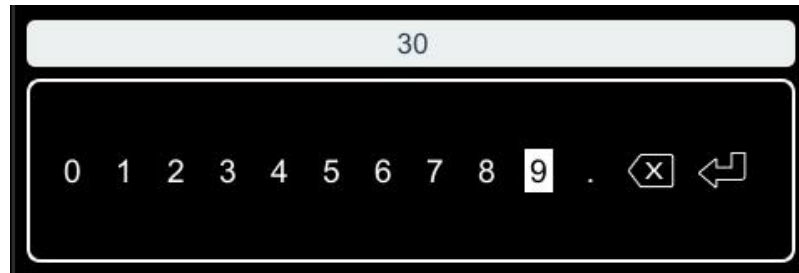

**Note:** If no settings are made on the numeric keyboard interface for more than 30 seconds, the instrument will automatically jump to the measurement display interface.

## 8 Start using

---

- To prevent electric shock accidents, please do not short circuit the top of the test line and the line with voltage.
- Do not measure AC voltage, AC current, or DC current. Otherwise, it may cause instrument damage or personal injury accidents.
- To prevent electric shock, please confirm the rated value of the test wire before measurement, and do not measure voltage higher than the rated value.

### 8.1 Measurement Settings

---

Click the **[Range]** button to enter the measurement display interface.



Click the **Type** menu soft key to select categories such as V&R, Voltage, and Resistance.

### 8.2 Set voltage range

---

- 1 Press the **[Range]** key to enter the measurement page;
- 2 Click on the **Range (V)** menu soft key;
- 3 Use the menu soft key to select the range and complete the voltage range setting.

### 8.3 Setting the Resistance Range

---

- 1 Press the **[Range]** key to enter the measurement page;
- 2 Click on the **Range (R)** menu soft key;
- 3 Use the menu soft key to select the range and complete the setting of the resistance range.

## 8.4 Zeroing

---

Click on the **[0 ADJ]** key, or click on **[Utility]** ->**Cal** in sequence. After entering the password, click on the **[0 ADJ]** soft key to execute zero adjustment. After successful zero adjustment, the interface will pop up as shown in the following figure. If zero adjustment fails, please check if the short circuit is correct, and then perform zero adjustment until successful.

## 9 Remote Control

---

The internal resistance tester can be remotely controlled in the following three methods:

### 1、 User-defined programming:

The Standard Commands for Programmable Instruments (SCPI) command can be used to control the internal resistance tester. Please refer to HBT4000-SCPI for detailed instructions on commands and programming.

### 2、 Use IO software:

The user can use the IO software to send commands for remote control of the internal resistance tester. PC software IO provided by Keysight is recommended. You can log in to Keysight official website ([www.keysight.com](http://www.keysight.com)) to download the software.

#### operating steps:

- Establish communication between internal resistance tester and computer
- Run IO and search for internal resistance tester resources
- Open the Remote Command Control panel and send the command

The internal resistance tester can communicate with PC through the following interfaces:

- 1 **Controlled through USB**
- 2 **Controlled through LAN**
- 3 **Controlled through RS232/485**

The manual will provide detailed instructions on how to use the IO software provided by Keysight to remotely control the internal resistance tester through various interfaces.

# 10 Default value

The default setting of the machine factory, press the [P] key can restore the instrument state to the factory default value.

Function	Default value
Range	
Measurement type	V&R
Voltage range	Auto
Resistance range	Auto
MEA	
Sample	Slow
Average	1
Trigger	Internal
Absolute	Open
Delay(ms)	1
SAVE/LOAD	
Boot Set	Default
STAT	
Switch	OFF
Data Temp	1000
COMP	
Switch	Close
Comp Mode	Auto



Function	Default value
Buzzer	Close
Resistance	Limit
Voltage	Limit
Utility	
Brightness	50%
GPIB Address	2
Key tone	OFF
Language	Chinese
IP	192.168.1.127
MASK	255.255.255.0
IP MODE	Manual
Serial-Baud	9600
Serial-Data	7
Serial-Check	None
Serial-Stop	1

# 11 More Product Information

## 1. More Product Information

Click on **[Utility]** -> **Sys Info**, you can obtain the machine model, serial number, software version, and hardware version.

## 2. View the option information and the option installation

For more information on this product, please refer to the relevant manual (you can download it from Hantek's official website ([www.hantek.com](http://www.hantek.com))).

- HBT4000 Series - User Manual: provides the function of this product to introduce the operation method, remote control method, possible faults in the use process and processing methods, and order information.
- HBT4000-SCPI Programming Manual: provides the SCPI command set for this product.

## 12 Warranty Summary

Qingdao Hantek Electronics Co., Ltd. (hereinafter referred to as Hantek) promises that the host and accessories of its production instruments will have no material or process defects during the product warranty period.

During the warranty period, if the product is proven to be defective, Hantek will provide free repair or replacement for the user. Please refer to the official website of Hantek or the product warranty card for detailed warranty regulations. To obtain the full text of repair services or warranty instructions, please contact the Hantek repair center or local offices.

Except for the warranties provided in this summary or other applicable warranty cards, Hantek Company does not provide any other express or implied warranties, including but not limited to any implied warranties of product tradability and suitability for special purposes. Under no circumstances shall Hantek be liable for indirect, special or consequential losses.



---

地址：山东省青岛市高新区宝源路 780 号，联东 U 谷 35 号楼

总机：400-036-7077

电邮：service@hantek.com

电话：0532-55678770, 55678772, 55678773

邮编：266000

官网：www.hantek.com

青岛汉泰电子有限公司