



Hantek



HDG3000B series

Arbitrary waveform signal generator

User Manual

2022.05

Warranties and Declarations

Copyright

The copyright of this document belongs to Qingdao Hantek Electronics Co., LTD.

Statement

Qingdao Hantek Electronics Co., Ltd. reserves the right to amend this document without prior notice. Qingdao Hantek Electronics Co., Ltd. promises that the information provided is correct and reliable but does not guarantee that this document is free from errors. Before using this product, please make sure that the specifications of relevant technical documents are the latest effective version. If you use documents or products of Qingdao Hantek Electronics Co., LTD and need products, patents or works of third parties to cooperate with them, you shall be responsible for obtaining the consent and authorization of the third parties. The above consent and authorization shall not be the liability of Hantek.

Product certification

Hantek certified HDG3000B series arbitrary waveform signal generators to meet China's national industry standards and has passed the CE certification.

Contact us

If you have any questions when using the products of Qingdao Hantek Electronics Co., LTD., you can obtain service and support through the following ways:

Email: service@hantek.com, support@hantek.com

Website: <http://www.hantek.com>

Contents

Contents	I
Figures.....	XI
Tables.....	I
1 Safety requirements	1
1.1 Summary of general safety matters.....	1
1.2 Safety terms and symbols	2
1.3 Measurement category.....	3
1.4 Working conditions	3
1.5 Maintenance and cleaning	4
1.6 Environmental Precautions	5
2 Product features.....	6
3 Document overview	7
4 Quick start.....	9
4.1 General checking	9
4.2 Appearance and dimension.....	9
4.3 Preparation before use.....	10
4.3.1 Connect the power supply	10
4.3.2 Adjust the Handle	11

4.3.3	Set system language	11
4.4	Product Introduction	12
4.4.1	Front Panel	12
4.4.2	Rear Panel.....	14
4.4.3	Main interface	15
4.5	Parameter Setting Method	16
4.5.1	Numeric Keypad	16
4.5.2	Direction Keys and Knob	16
4.6	Using the built-in help system.....	17
5	Basic Waveform Output	18
5.1	Select the Channel.....	18
5.2	Set the Parameter	18
5.2.1	Select the Basic Waveform.....	18
5.2.2	Set the Frequency	18
5.2.3	Set the Amplitude	19
5.2.4	Set the DC Offset Voltage	20
5.2.5	Set the Start Phase.....	20
5.2.6	Set the Duty Cycle	21
5.2.7	Set the Symmetry	22

5.2.8	Set the Pulse Parameters.....	22
5.2.9	Enable the Channel Output	24
5.3	Basic Waveform Output Example.....	24
6	Arbitrary Waveform Output	26
6.1	Enable Arbitrary Waveform	26
6.2	Select Arbitrary Waveform	26
7	Harmonic Output.....	32
7.1	Overview	32
7.2	Set the Basic Waveform Parameters.....	32
7.3	Set the Harmonic Order	32
7.4	Set the Harmonic Type.....	33
7.5	Set the Harmonic Amplitude.....	33
7.6	Set the Harmonic Phase	34
8	Modulation	35
8.1	AM Modulation	35
8.1.1	Select AM Modulation.....	35
8.1.2	Carrier Waveform Shape	35
8.1.3	Carrier Waveform Frequency	35
8.1.4	Modulation Source.....	35

8.1.5	Modulation Frequency	36
8.1.6	Modulation Depth.....	37
8.2	DSB-AM Modulation.....	37
8.2.1	Select DSB-AM Modulation	37
8.2.2	Carrier Waveform Shape	37
8.2.3	Carrier Waveform Frequency	37
8.2.4	Modulation Source.....	38
8.2.5	Modulation Frequency	38
8.2.6	Modulation Depth.....	39
8.3	FM Modulation	39
8.3.1	Select FM Modulation	39
8.3.2	Carrier Waveform Shape	39
8.3.3	Carrier Waveform Frequency	40
8.3.4	Modulation Source.....	40
8.3.5	Modulation Frequency	41
8.3.6	Frequency Deviation.....	41
8.4	PM Modulation	41
8.4.1	Select PM Modulation.....	41
8.4.2	Carrier Waveform Shape	42

8.4.3	Carrier Waveform Frequency	42
8.4.4	Modulation Source	42
8.4.5	Modulation Frequency	43
8.4.6	Phase Deviation.....	43
8.5	ASK Modulation	43
8.5.1	Select ASK modulation	44
8.5.2	Carrier Waveform Shape	44
8.5.3	Carrier Waveform Amplitude	44
8.5.4	Modulation Source	44
8.5.5	ASK Rate	45
8.5.6	Modulation Amplitude	45
8.6	FSK Modulation.....	45
8.6.1	Select FSK Modulation	45
8.6.2	Carrier Waveform Shape	45
8.6.3	Carrier Waveform Frequency	46
8.6.4	Modulation Source	46
8.6.5	FSK Rate	46
8.6.6	Hopping Frequency	47
8.7	PSK Modulation	47

8.7.1	Select PSK Modulation	47
8.7.2	Carrier Waveform Shape	47
8.7.3	Carrier Waveform Phase	47
8.7.4	Modulation Source	48
8.7.5	PSK Rate	48
8.7.6	Modulation Phase	48
8.8	BPSK Modulation	48
8.8.1	Select BPSK Modulation.....	49
8.8.2	Carrier Waveform Shape	49
8.8.3	Carrier Waveform Phase	49
8.8.4	Modulation Source	49
8.8.5	BPSK Rate.....	49
8.8.6	Modulation Phase	49
8.9	QPSK Modulation.....	50
8.9.1	Select QPSK Modulation	50
8.9.2	Carrier Waveform Shape	50
8.9.3	Carrier Waveform Phase	50
8.9.4	Modulation Source	50
8.9.5	QPSK Rate	50

8.9.6	Modulation Phase	51
8.10	3FSK Modulation.....	51
8.10.1	Select 3FSK Modulation	51
8.10.2	Carrier Waveform Shape	51
8.10.3	Carrier Waveform Frequency	51
8.10.4	Modulation Source.....	52
8.10.5	3FSK Rate	52
8.10.6	Hopping Frequency	52
8.11	4FSK Modulation.....	52
8.11.1	Select 4FSK Modulation	52
8.11.2	Carrier Waveform Shape	52
8.11.3	Carrier Waveform Frequency	53
8.11.4	Modulation Source.....	53
8.11.5	4FSK Rate	53
8.11.6	Hopping Frequency	53
8.12	OSK Modulation.....	53
8.12.1	Select OSK Modulation.....	54
8.12.2	Carrier Waveform Shape	54
8.12.3	Carrier Waveform Frequency	54

8.12.4	Modulation Source.....	54
8.12.5	OSK Rate.....	55
8.12.6	Oscillate Time.....	55
8.13	PWM Modulation.....	55
8.13.1	Select PWM Modulation.....	55
8.13.2	Carrier Waveform Shape.....	56
8.13.3	Carrier Waveform Duty.....	56
8.13.4	Modulation Source.....	56
8.13.5	Modulation Frequency.....	57
8.13.6	Duty Deviation.....	57
9	Sweep.....	58
9.1	Select Sweep.....	58
9.2	Start Frequency and Stop Frequency.....	58
9.3	Center Frequency and Frequency Span.....	58
9.4	Linear Sweep.....	59
9.5	Sweep Time.....	59
9.6	Return Time.....	60
9.7	Hold Time.....	60
9.8	Mark Frequency.....	60

9.9	Sweep Trigger Source.....	60
9.10	Trigger Output Edge.....	61
10	Burst.....	62
10.1	Select Burst.....	62
10.2	Burst Type.....	62
10.3	Burst Count	64
10.4	Burst Period	64
10.5	Burst Phase	65
10.6	Trigger Source	65
10.7	Gate Polarity	66
10.8	Trigger Output Edge.....	66
11	Counter	67
12	Store	68
12.1	Store System	68
12.2	File Operation	68
13	Utility	71
13.1	Sync.....	71
13.2	Impedance Settings	72
13.3	System Settings	73

- 13.3.1 Language 73
- 13.3.2 Clock Source 73
- 13.3.3 Power On Settings 74
- 13.3.4 Intensity..... 74
- 13.3.5 System Information..... 74
- 13.3.6 Unit..... 74
- 13.3.7 Save Picture 75
- 13.4 Firmware Update.....75
- 14 Remote Control76
 - 14.1 Install Keysight IO libraries suite76
 - 14.2 Remote Control via USB80
- 15 Troubleshoot83
- 16 Appendix84
 - 16.1 Appendix A: Accessories.....84
 - 16.2 Appendix B: Warranty summary84

Figures

Figure 4.1 Front view	9
Figure 4.2 Top view.....	10
Figure 4.3 Front Panel.....	12
Figure 4.4 Rear Panel	14
Figure 4.5 User Interface.....	15
Figure 5.1 Before.....	21
Figure 5.2 After	21
Figure 5.3 Setting Interface	25
Figure 5.4 Output Waveform	25
Figure 6.1 Arbitrary Interface.....	26
Figure 8.1 OSK Modulation	54
Figure 10.1 N Cycle Burst.....	63
Figure 10.2 Infinite Cycle Burst.....	63
Figure 10.3 Gate Burst	64
Figure 11.1 Counter.....	67
Figure 12.1 Store Interface.....	68
Figure 12.2 New File Interface.....	69
Figure 12.3 Rename Interface	70
Figure 13.1 Impedance.....	72

Tables

Table 3.1 Knob.....	7
Table 3.2 Mode	8
Table 6.1 Build-In waveform	30
Table 10.1 Table Burst type	62

1 Safety requirements

1.1 Summary of general safety matters

Read the following safety precautions carefully to avoid injury and to prevent damage to this product or any product connected. To avoid possible dangers, please use this product in accordance with the regulations.

- **Only professionally authorized personnel can perform repairs.**

- **Use the right power cable.**

Use the power cable approved by the country in which the product is used only.

- **Connect and disconnect correctly.**

Before connecting the probe to the circuit being measured, please connect the probe to the oscilloscope first. Before disconnecting the probe from the oscilloscope, please disconnect the probe and the circuit under test first.

- **Ground the product.**

To avoid electric shocks, the product is grounded through a grounding conductor of the power cable. The grounding conductor must be connected to the ground before connecting the input or output terminals of the product. Ensure that the product is properly grounded.

- **Connect the probe properly.**

The ground wire of the probe is the same as the ground potential. Do not connect the ground wire to high voltage.

- **View all terminal rating values.**

To avoid fire or excessive current, please check all rating values and signs on the product. Please consult the product manual for details of the rating values before connecting the product.

- **Do not operate with the cover open.**

Do not run the product with the cover or panel open.

- **Avoid circuit exposure.**

Do not touch exposed connectors and components after power is switched on.

- **Do not operate if the product is suspected to be faulty.**

If you suspect that the product has been damaged, please ask qualified maintenance personnel to check it.

- Maintain proper ventilation.
- Do not operate in a humid environment.
- Do not operate in inflammable or explosive environment.
- Please keep the product surface clean and dry.

**Warning:**

Equipment that meets Class A requirements may not provide adequate protection for broadcast services in residential environments.

1.2 Safety terms and symbols

Safety terms in this manual:

**Dangerous**

Indicates that immediate damage may be caused to you if you perform this operation.

**Warning:**

Indicates that it may not cause immediate damage to you if you perform this operation.

**Note**

Indicates that you may cause damage to this product or other properties if you do so.

Safety terms on the product:

Warning:

Indicates a potential hazard to you if you do not perform this operation.

Safety symbols on the product:



警告



壳体接地端

1.3 Measurement category

Measurement category

This instrument can be used for measurement under class I.



Warning:

This instrument is only allowed to be used in the specified measurement class.

Measurement class definition

- **Class I refers to measurements taken on a circuit not directly connected to the main power supply.** For example, measurements made on circuits that are not exported from a main power supply, especially from a protected (internal) main power supply. In the latter case, the instantaneous stress will change. Therefore, the user should understand the instantaneous capacity of the instrument.
- **Class II refers to measurements taken on a circuit directly connected to low-voltage instruments.** For example, measurements made on household appliances, portable tools, and similar equipment.
- **Class III refers to measurements taken on construction equipment.** For example, measurements made on switchboards, circuit breakers, circuits (including cables, busbars, junction boxes, switches, sockets) in fixed equipment, as well as equipment for industrial use and certain other equipment (for example, fixed motors permanently connected to fixed instruments).
- **Class IV refers to measurements taken at the source of low-voltage equipment.** For example, measurements made on electricity meters, primary overcurrent protection equipment, and pulse control units.

1.4 Working conditions

Temperature

Operating temperature: 0°C - 45°C

Storage temperature: 20°C - 60°C

Humidity

≤+104°F (≤+40°C): relative humidity≤90%

106°F ~122°F (+41°C ~50°C): relative humidity≤60%



Warning:

To avoid the danger of short circuit or electric shock, do not operate the instrument in a humid environment.

Altitude

When operating: below 3,000 meters.
When not operating: below 15,000 meters.

Installation (over voltage) Class This product is powered by a main power source that complies with Installation (over voltage) Class II.



Warning:

Make sure that no overvoltage (such as that caused by lightning) reaches the product. Otherwise the operator may be in danger of receiving an electric shock.

Installation (overvoltage) Class definition

Class I refers to the signal level, which is applicable to the measuring terminal of the instrument connected to the source circuit. Measures have been taken to limit the instantaneous voltage to the corresponding low level.

Class II refers to the local distribution level, which is applicable to instruments connected to the mains (AC) supply.

Degree of pollution

Class 2

Pollution level definition

- **Level 1:** No pollution, or only dry non-conductive pollution. This pollution level has no impact. For example: clean room or air-conditioned office environment.
- **Level 2:** Generally, only dry non-conductive pollution. Temporary conduction due to condensation may sometimes occur. For example: general indoor environment.
- **Level 3:** Conductive pollution, or dry non-conductive pollution becoming conductive due to condensation. For example, an outdoor environment with a canopy.
- **Level 4:** Permanent conductive pollution through conductive dust, rain, or snow. For example: outdoor places.

Security level

Level 1 - Grounded products

1.5 Maintenance and cleaning

Maintenance:

Do not make the LCD exposed to direct sunlight for a long time when placing the oscilloscope.

Cleaning:

Regularly check the oscilloscope and probe according to the requirements of the operating conditions, please follow the following steps to clean the outer surface of the

instrument:

- 1) Using a lint-free cloth to remove the dust from the outside of the oscilloscope and probe. Please be careful to avoid scratching the smooth display filter material.
- 2) Using a soft cloth soaked with water to clean the oscilloscope. For more thoroughly clean, use 75% isopropyl alcohol aqueous solvent



Note:

To avoid damage to the oscilloscope or the surface of the probe, please do not use any corrosive reagent or chemical cleaning reagent.



Warning:

Before repowering, please make sure the instrument is completely dry, to avoid electrical short circuit or even personal injury caused by moisture.

1.6 Environmental Precautions

The following sign indicates that this product conforms to the requirements set out by the WEEE Directive 2002/96/EC.



Equipment recycling:

Producing the instrument requires the extraction and use of natural resources. Some substances contained in the instrument may be harmful to the environment or human health if the product is not disposed of properly. To avoid the release of harmful substances into the environment and reduce the use of natural resources, it is recommended that appropriate methods be used to recycle this product to ensure that most of the materials can be correctly reused.

2 Product features

Product features

- Frequency range(CH1/CH2): 1 μ Hz ~ 100MHz/80MHz/60MHz/40MHz/25MHz;
- Sampling rate up to 300MSa/s, 16 bits vertical resolution to ensure the accuracy of waveform amplitude;
- Double channels with equal performance, equivalent to two independent signal sources;
- Storage depth up to 2M to create more waveform cycles as well as the better waveform details;
- Rich modulation functions, supporting for AM, DSB - AM, FM, PM, ASK, FSK and PSK, BPSK, QPSK, 3 FSK, 4 FSK, OSK and PWM, etc.;
- There are more than 160 arbitrary signals such as exponential rise, exponential fall, ECG signal, Gaussian, half orthogonality, Lorentz, dual tone multi-frequency, DC voltage, etc.
- 4.3-inch color TFT LCD screen, clear and intuitive user interface;
- Built-in high resolution 80MHz frequency meter;
- Standard communication interface: front USB Host and rear USB Device;
- Built-in harmonic generator function with 16 harmonic frequency, output harmonic with a specified number of times, amplitude and phase, usually used in harmonic detection equipment or the testing of harmonic filtering equipment.

HDG3000B has 5 functions, that are arbitrary waveform generator, pulse generator, function generator, harmonic generator, frequency meter all in one; Using DDS (direct digital frequency synthesis) technology, which can generate stable, pure and low distortion output signal; User-friendly interface design and keyboard layout bring users extraordinary experience; Rich configuration interfaces can easily realize computer control, providing more solutions to user measurement.

3 Document overview

This document is used to guide the user to quickly understand the front and back panels, user interfaces, and basic operation methods of the HDG3000B series signal generators.



Tip:

The latest version of this manual can be downloaded at (<http://www.hantek.com>).

Document number:

202205

Software version:

Software upgrade may change or increase product functionalities, please pay attention to Hantek website for the latest version.

Document format conventions:

1 Keys

Use "square brackets + text (bold)" to represent front panel keys, such as **[Utility]** for the "Utility" key.

2 Menu

Use blue menu text (bold) to represent a menu option, for instance, **Basic Settings** indicates clicking the "Basic Settings" option on the current operation interface to enter the configuration menu of "Basic Settings".

3 Operation flow

Use ">" to indicate the next operation, for instance, **[Utility]** > **Store** indicates clicking **[Utility]** and then click the **Store** function key.

4 Knob

Symbol	Knob
	Multi-function knob

Table 3.1 Knob

Document content conventions:

The HDG3000B signal generator contains the following models.

Model	Number of channels	Maximum frequency	CH1/CH2 sampling rate
HDG3102B	2	15MHz	300MS/s
HDG3022B	2	25MHz	300MS/s
HDG3042B	2	40MHz	300MS/s
HDG3062B	2	60MHz	300MS/s
HDG3082B	2	80MHz	300MS/s
HDG3102B	2	100MHz	300MS/s

Table 3.2 Mode

4 Quick start

4.1 General checking

Check the shipping package

After receiving the oscilloscope, please follow the following steps to check the instrument: Check whether there is any damage caused by transportation: If the packaging cartons or protective foam pads are seriously damaged, please keep them until the whole machine and accessories pass the electrical and mechanical testing.

Check the accessories

The details of the accessories are provided in Appendix A: Accessories at the end of the user manual. If you find any accessory missing or damaged, please contact the dealer responsible for this business.

Check the machine

If you find the instrument is damaged, not working properly, or unable to pass the performance test, please contact the dealer responsible for this business.

4.2 Appearance and dimension

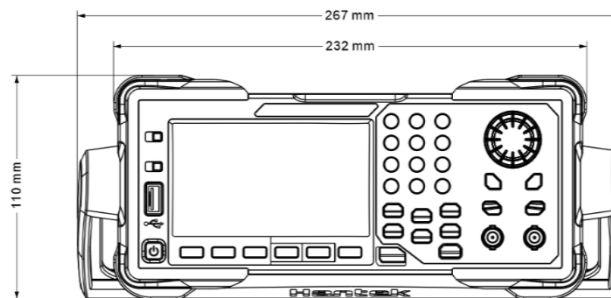

Figure 4.1 Front view

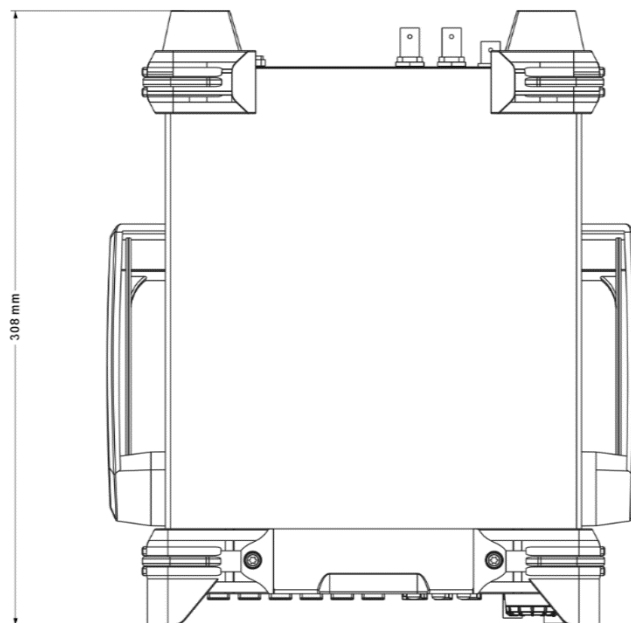

Figure 4.2 Top view

4.3 Preparation before use

4.3.1 Connect the power supply

Connect the power cord as needed.

The input AC power specifications of this series of signal generators are: 100-120 VAC ($\pm 10\%$), 45-440 Hz or 120-240 VAC ($\pm 10\%$), 45-66Hz. Please use the supplied power cord to connect the machine to AC power.

Press the power switch in the lower left corner of the front panel to turn on the instrument. If the instrument does not turn on, verify that the power cord is securely connected and that the instrument is connected to a live power source.

Switch:



To turn off the instrument, press the power switch.



Warning:

To avoid electric shock, make sure the instrument is properly grounded.

4.3.2 Adjust the Handle

To adjust the handle of the instrument, hold both sides of the handle and pull them outward, then rotate the handle.

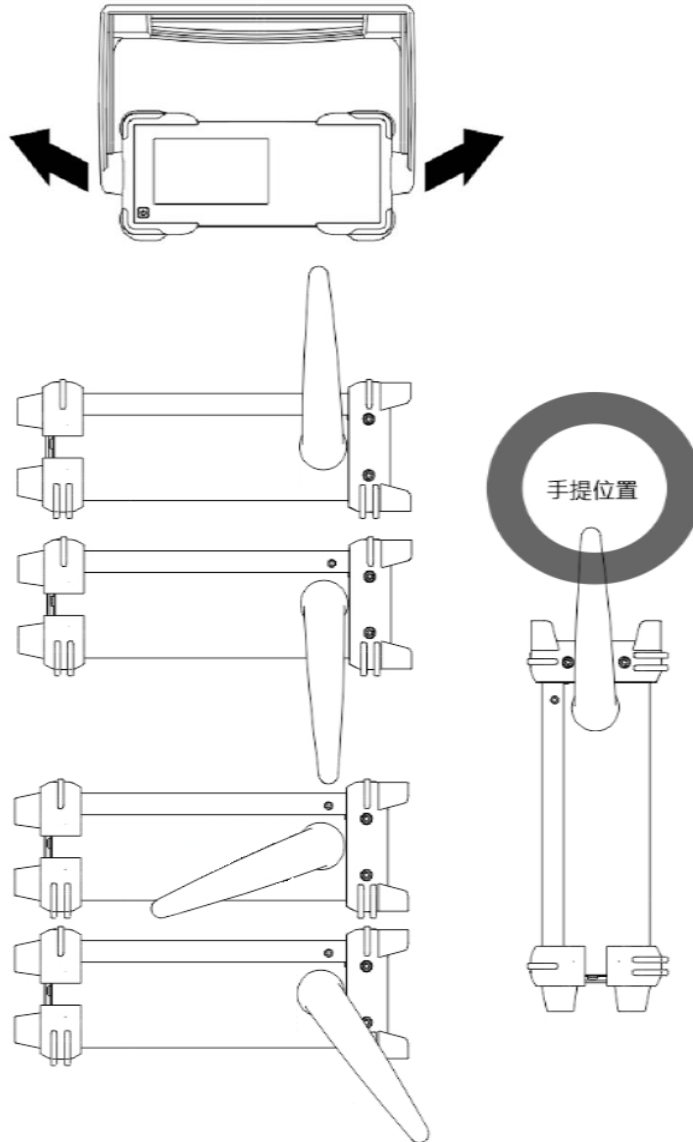

4.3.3 Set system language

The signal generator supports Chinese and English menus, and provides corresponding help information, prompt information and interface display.

Press **[Utility] > Language** to select the desired language. When "Chinese" or "English" is selected, the menu, help information, prompt message and interface are displayed in Chinese or English respectively.

4.4 Product Introduction

This chapter describes the front and rear panels and user interface of the machine.

4.4.1 Front Panel



Figure 4.3 Front Panel

1. On/Off Switch

2. Menu Softkey

Correspond to the left menus respectively. Press any softkey to activate the corresponding menu.

3. Function Keys

- [Wave]: Select the waveform that the current channel will output.
- [Setting]: Set the parameters of the waveform that the current channel will output.
- [Utility]: Auxiliary functions and system Settings. Used to set auxiliary function and system parameters.
- [Mod]: Enable generate modulated waveforms. A variety of analog and digital modulation methods are provided to generate AM, DSB-AM, FM, PM, ASK, FSK, PSK, BPSK, QPSK, 3FSK, 4FSK, OSK and PWM modulation signals.
- [Sweep]: Enable generate sweep signals of "sine", "square", "ramp", "pulse", "harmonic" and "arbitrary (except DC)".
- [Burst]: Enable generate burst signals of "sine", "square", "ramp", "pulse", "harmonic" and "arbitrary (except DC)".
- [Trigger]: Manually triggered button. In sweep or burst mode, used to manually trigger CH1 or CH2 to produce a sweep or burst signal (only when 1Output or 2Output is turned on).
- [CH1/2]: Channel switching. Press this button to switch menu setting channel. After selecting CH1, users can set the waveforms, parameters, and configuration of CH1.

After selecting CH2, users can set the waveforms, parameters, and configuration of CH2.

4. CH1/CH2 Output Connector

BNC connector with 50Ω nominal output impedance.

When **1Output** or **2Output** is enabled (the backlight turns on), this connector output waveform according to the current configuration of the channel.

5. Channel ON/OFF:

Enable or disable the output of CH1 or CH2.

6. Direction Keys

When using the knob and direction keys to set parameters, the direction keys are used to switch the digits of the parameter.

During file name input, they are used to move the cursor.

7. Knob

During parameter setting, it is used to increase (clockwise) or decrease (counterclockwise) the current highlighted number. It is used to select file storage location or select the file to be recalled when storing or recalling file. It is used to switch the character in the soft keyboard when entering filename.

8. Numeric Keypad

It is used to input parameters and consists of numbers (0 to 9), decimal point (.), operators (+/-). Note that if a negative is required, please input an operator "-" before the numbers. (For the use method of the numeric keypad, refer to the introduction in "[Parameter Setting Method](#)").

9. LCD

4.3-inch color TFT LCD screen, display the current function menu and parameter settings, system state as well as prompt messages.

10. Default

It is used to restore the instrument state to the factory default settings.

11. Help

To get the context help information about any front-panel key or menu softkey, press this key and then press the button you need to get the help information for.

12. USB HOST Interface

External storage device (USB disk) can be accessed for saving or loading settings files. The file system format of the external storage device is FAT32 and the memory is no more than 32G.

4.4.2 Rear Panel



Figure 4.4 Rear Panel

1. CH1/CH2 Sync/ExtMod/Trig Connector

BNC connector with 50 Ω nominal output impedance and 1K Ω nominal input impedance.

Its function is determined by the current working mode.

- **Sync:**When **1Output** is enabled, this connector outputs the sync signal corresponding to the current settings of CH1 (refer to the introduction in [Sync](#)).
- **ExtMod:**If modulation mode is enabled for CH1, and external modulation source is used, this connector accepts an external modulation signal.
- **Trig:**If CH1 is in sweep or burst mode and external trigger source is used, this connector accepts an external trigger signal (the polarity of the signal can be set).

2. 10 MHz Reference In/Out (10MHz In/Out)

BNC connector with 50 Ω nominal output impedance and 5K Ω nominal input impedance. The function of this connector is determined by the type of clock used by the generator. HDG3000B can use internal or external clock (refer to the introduction in "[Clock Source](#)").

- When internal clock source is used, the connector (used as 10MHz Out) can output 10MHz clock signal generated by the internal crystal oscillator of the generator.
- When external clock source is used, the connector (used as 10MHz In) accepts a 10MHz external clock signal.
- This connector is usually used to synchronize multiple instruments (refer to the introduction in "[Clock Source](#)").

3. Counter (0~3.3V, external signal input)

BNC connector with 500 Ω nominal input impedance. It is used to accept an

external signal to be measured by the counter.

4. **USB DEVICE Interface**
5. **Safety Lock Hole**
6. **AC Power Socket**

4.4.3 Main interface

The user interface is shown in the following figure.

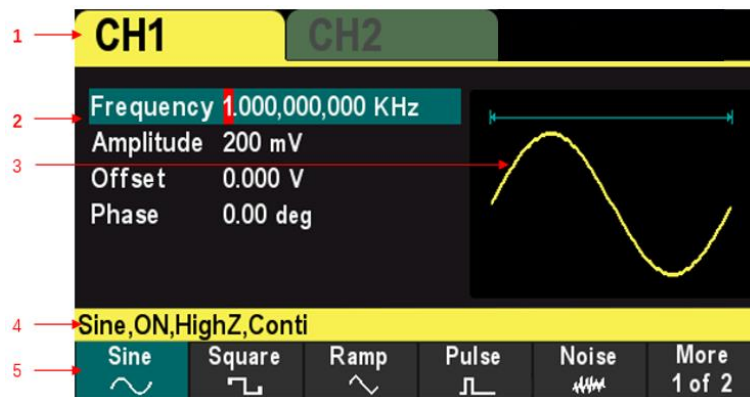

Figure 4.5 User Interface

1. Displays the selected channel.

CH1、CH2

2. Channel Parameters

Display the waveform parameters of the current channel.

Press the parameter softkey and use the numeric keypad or direction keys and knob to modify the value. The parameters that can be modified will be highlighted, and the red background of the number indicates the current cursor position.

3. Waveform

Display the selected waveform type of the current channel.

4. Channel Configuration

Displays the output configuration of the current channel, including waveform type, output impedance, operating mode and output state.

Output Impedance: HighZ (High Impedance) or 50Ω.

Mode: Modulation, Sweep, Burst or Continuous output.

5. Menu

Displays the operation menu corresponding to the currently selected function. For example, the function menu of the **[Wave]** button is displayed in the figure.

4.5 Parameter Setting Method

Users can use the numeric keypad or knob and direction keys to set parameters.

4.5.1 Numeric Keypad

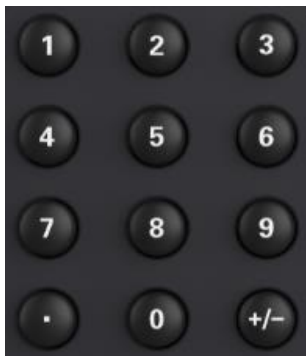

The numeric keypad consists of the following parts:

- 1. Number keys**
The 0 to 9 number keys are used to directly input the desired parameter value.
- 2. Decimal point**
Press this key to insert a decimal point "." at the current position of the cursor.
- 3. Operator Key**
The operator key "+/-" is used to modify the operator of the parameter. Press this key to set the parameter operator to "-"

4.5.2 Direction Keys and Knob



Arrow key functions include:

During parameter input, the direction keys are used to move the cursor to select the currently edited bit.

When editing the file name, the arrow keys are used to move the cursor position.

**Knob functions include:**

- In the parameter editable state, rotating the knob will increase (clockwise) or decrease (counterclockwise) the parameter in specified steps.
- When editing the file name, the knob is used to select different characters in the soft keyboard.
- In **[Wave] > Arb > Type > Custom**, the knob is used to select different arbitrary waveform files.
- In the store and recall function, the knob is used to select the location where the file is saved or the file to be read.

4.6 Using the built-in help system

To get help on any front-panel key or menu softkey, first press the front-panel **[?]** key, then the key for which you want help.

If there are indexes for other topics in the content view, the user can rotate the knob to select a different index, press the button to enter the corresponding topic content.

Press the **[?]** key again to exit.

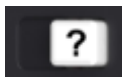

5 Basic Waveform Output

HDG3000B can output basic waveforms (including Sine, Square, Ramp, Pulse and Noise) from one of the channels separately or from the two channels at the same time. At start-up, the channel is configured as a sine waveform with 1KHz frequency and 200mVpp amplitude by default. This chapter introduces how to configure the instrument to output various basic waveforms.

5.1 Select the Channel

Users can configure HDG3000B to output basic waveform from a single channel or from dual channels at the same time. Please select the desired channel before configuring waveform parameters. At start-up, CH1 is selected by default.

Press **[CH1/2]** button on the front panel and the corresponding area in the user interface is illuminated. At this point, users can configure the waveform and parameters of the channel selected.

Note: CH1 and CH2 cannot be selected at the same time. Users can first select CH1 and then select CH2 after configuring the waveform and parameters of CH1.

5.2 Set the Parameter

5.2.1 Select the Basic Waveform

HDG3000B can output 5 kinds of basic waveforms, including Sine, Square, Ramp, Pulse and Noise. At start-up, Sine is selected by default.

Press **[Wave]** button on the front panel, and then press the corresponding softkey in the menu to select the waveform and enter the parameter setting menu. Now the user interface displays the selected waveform shape.

Press **[Wave] > CH1=CH2** softkey to change the settings of another channel to be the same as the settings of the current channel.

5.2.2 Set the Frequency

Frequency is one of the most important parameters of the basic waveforms. For different models and different waveforms, the setting ranges of the frequency are different. For detailed information, please refer to "Frequency Characteristics" in "Specifications". The default frequency is 1 KHz.

The frequency displayed on the screen is the default value or the frequency previously set. When the instrument function is changed, if this frequency is valid under the new function, the instrument will still use this frequency; otherwise, the instrument would

display prompt message and set the frequency to the frequency upper limit of the new function automatically.

Press **[Setting] > Frequency** softkey. At this point, use the numeric keypad to input the value of the frequency and select the desired unit from the pop-up unit menu, or use the direction keys and knob to modify the current value.

1. For the input method of frequency value, please refer to the introduction of "[Parameter Setting Method](#)".
2. The frequency units available are MHz, KHz, Hz and mHz.
3. Press **[Utility] > Units** softkey and press Frequency/Period softkey to switch Frequency in the parameter to Period. Press **[Setting] > Period** softkey to modify the period parameter.
4. The period units available are sec, msec, μ sec and nsec.

5.2.3 Set the Amplitude

The amplitude range is limited by Frequency or Period and Impedance settings. Please refer to "Output Characteristics" in Specifications. The default value is 200mVpp.

The amplitude displayed on the screen is the default value or the amplitude previously set. When the instrument configuration (e.g. frequency) is changed, if this amplitude is valid, the instrument will still use this amplitude; otherwise, the instrument would display a prompt message and set the amplitude to the amplitude upper limit of the new configuration automatically.

Press **[Setting] > Amplitude** softkey. At this point, use the numeric keypad to input the value of the amplitude and select the desired unit from the pop-up unit menu, or use the direction keys and knob to modify the current value.

1. For the input method of amplitude value, refer to the introduction in "[Parameter Setting Method](#)".
2. The amplitude units available are Vpp, mVpp, and Vrms, dBm (50 Ω impedance).
3. Press **[Utility] > Units** softkey and press **Amplitude/High Level** softkey to switch the **Amplitude** and **Offset** in the parameter to **High Level** and **Low level**. Press **[Setting] > High Level** or **Low Level** softkey to modify high level or low level parameters.
4. The high level units available are V and mV.

Tips:

Switch between Vpp and Vrms

Vpp is the unit for the signal peak-peak value and Vrms is the unit for the signal effective value. The default unit of the instrument is Vpp. Users can quickly switch the current amplitude unit from the front panel.

For different waveforms, the relations between Vpp and Vrms are different. Take sine waveform as an example; the relation of the two units is as shown in the figure below.

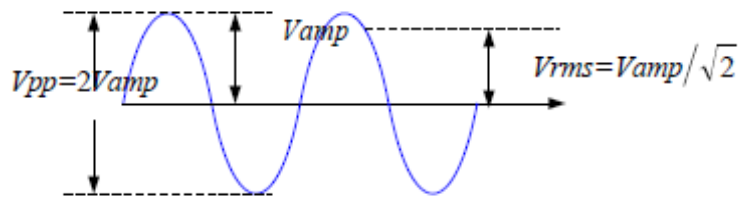

According to the figure above, the conversion relation between V_{pp} and V_{rms} fulfills the following equation.

$$V_{pp} = 2\sqrt{2}V_{rms}$$

For example, convert 2V_{pp} to the corresponding value in V_{rms}.

For sine waveform, press in the numeric keypad to enter 0.707 and select the V_{rms} menu.

5.2.4 Set the DC Offset Voltage

The settable range of the DC offset voltage is limited by the Amplitude and Impedance settings. Please refer to the "Output Characteristics" in Specifications. The default value is 0VDC.

Press **[Setting] > Offset** softkey. At this point, use the numeric keypad to enter the offset value and select the desired unit from the pop-up unit menu, or use the direction keys and knob to modify the current value.

1. For the input method of offset value, refer to the introduction in "[Parameter Setting Method](#)".
2. The DC offset voltage units available are V and mV.
3. Press **[Utility] > Units** softkey and press **Offset/Low Level** softkey to switch **Amplitude** and **Offset** in the parameter to **High** and **Low level**. Press **[Setting] > High level** or **Low level** softkey to modify high-level or low-level parameters.
4. The low level units available are V and mV.

5.2.5 Set the Start Phase

Press **[Setting] > Phase** softkey to enter the phase submenu. At this point, use the numeric keypad to input the value of the phase and select the unit "Degree" from the unit menu that pops up, or use the direction keys and the knob to modify the current value.

1. For the input method of phase value, refer to the introduction in "[Parameter Setting Method](#)".
2. The starting phase can be set from 0° to 360°. The default value is 0°.
3. Press **0 Phase** softkey to quickly set the phase to 0°.
4. Press **Sync** softkey to synchronize the phase of the two channels (CH1 and CH2) with each other.

For two signals whose frequencies are the same or in multiple, this operation will align their phases. For example, assume a sine waveform (1KHz, 8Vpp, 0°) is output from CH1, while another (1KHz, 8Vpp, 180°) from CH2. Use an oscilloscope to sample and display the waveforms of the two channels. You will see that the phase deviation of the two waveforms displayed on the oscilloscope is not 180°. At this point, press **Sync** softkey on the generator and the waveforms shown on the oscilloscope will have a phase deviation of 180° without any adjustment of the start phase of the generator.

Before synchronizing phase:

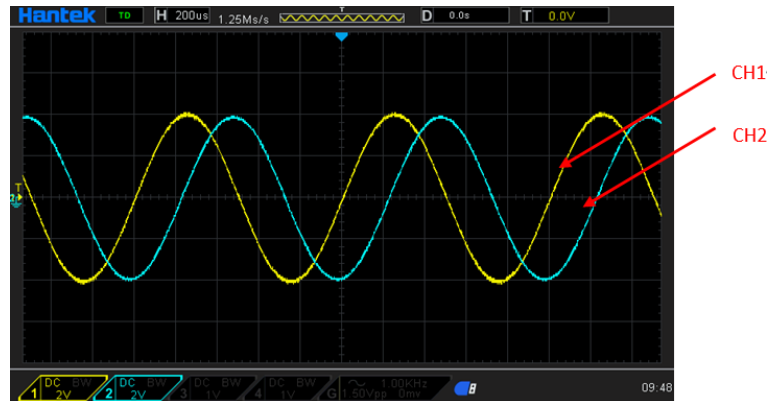

Figure 5.1 Before

After synchronizing phase:

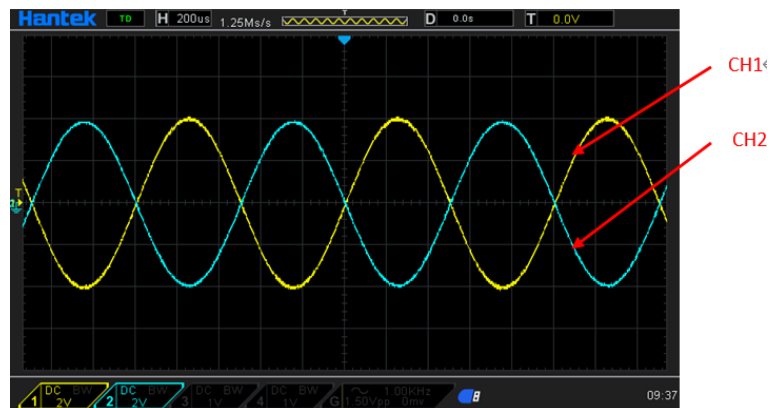
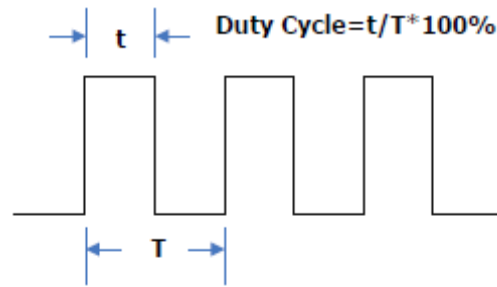

Figure 5.2 After

5.2.6 Set the Duty Cycle

Duty cycle is defined as the percentage that the high level takes up in the whole period as shown in the figure below.



The duty cycle range is limited by the "Frequency/Period" setting. Please refer to "Signal Characteristics" in Specifications. The default value is 50%.

Press **[Wave]** > **Square** softkey to select the square waveform function and press **Duty** softkey to highlight it. At this point, use the numeric keypad to input the value and select the unit "%" from the unit menu that pops up, or use the direction keys and the knob to modify the current value. For the input method of duty cycle value, refer to the introduction in "[Parameter Setting Method](#)".

5.2.7 Set the Symmetry

Symmetry is defined as the percentage that the rising period takes up in the whole period as shown in the figure below. This parameter is only available when ramp is selected.

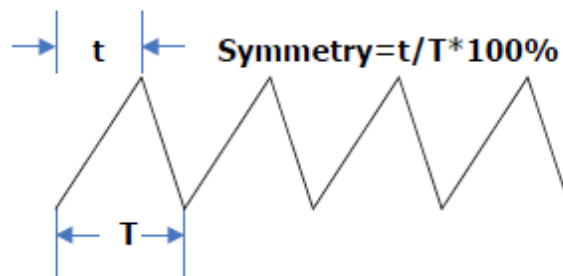

Symmetry can be set in the range of 0% to 100%. The default value is 50%.

Press **[Wave]** > **Ramp** softkey to select the ramp wave function and press **Symmetry** softkey to highlight it. At this point, use the numeric keypad to input the value and select the unit "%" from the unit menu that pops up, or use the direction keys and the knob to modify the current value. For the input method of symmetry value, refer to the introduction in "[Parameter Setting Method](#)".

5.2.8 Set the Pulse Parameters

To output a pulse, users need to set the "Width/Duty", "Leading" and "Trailing", in addition to the basic parameters (such as the frequency, amplitude, DC offset voltage, high level, low level and align phase) introduced above.

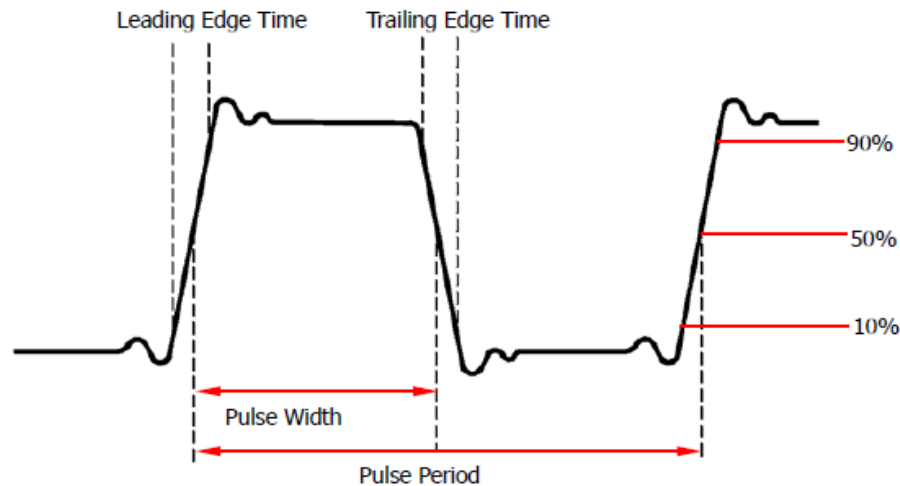

Pulse width/duty cycle

Pulse width is defined as the time from the 50% threshold of a rising edge amplitude to the 50% threshold of the next falling edge amplitude as shown in the figure above.

The settable range of the pulse width is limited by the "Minimum Pulse Width" and the "Pulse Period" (for the ranges of the "Minimum Pulse Width" and "Pulse Period", please refer to "Signal Characteristics" in Specifications). The default value is 100 μ s.

1. Pulse Width \geq Minimum Pulse Width
2. Pulse Width \leq Pulse Period - Minimum Pulse Width

Pulse duty cycle is defined as the percentage that the pulse width takes up in the whole pulse period.

The pulse width and pulse duty cycle are correlative. Once a parameter is changed, the other will be automatically changed. The pulse duty cycle is limited by the "Minimum Pulse Width" and "Pulse Period".

1. Pulse Duty Cycle \geq Minimum Pulse Width \div Pulse Period \times 100%
2. Pulse Duty Cycle \leq (1 - Minimum Pulse Width \div Pulse Period) \times 100%

Press **[Wave]** > **Pulse** softkey to select the pulse wave function and press **Width** softkey to highlight it. At this point, use the numeric keypad to input the value and select the desired unit from the unit menu that pops up, or use the direction keys and knob to modify the current value.

1. For the input method of the value, refer to the introduction in "[Parameter Setting Method](#)".
2. The width units available are sec, msec, μ sec and nsec.
3. Press **[Utility]** > **Units** softkey and press **Width/Duty** softkey to change **Width** in the parameter to **Duty**. Press **[Setting]** > **Duty** softkey to modify the duty cycle parameters.

Leading/Trailing Edge Time

The leading (rising) edge time is defined as the time required for the pulse amplitude to

rise from 10% threshold to 90% threshold; while the trailing (falling) edge time is defined as the time required for the pulse amplitude to fall from 90% threshold to 10% threshold as shown in the figure above.

The range of the leading/trailing edge time is limited by the pulse width currently specified as shown in the formula below. The edge time will be automatically adjusted to match the specified pulse width if the value currently set exceeds the limit value.

Press **[Wave]** > **Pulse** softkey to select pulse wave function and press **Edge Time** softkey to enter the Edge Time sub-menu. Press **Leading** or **Trailing** softkey to highlight it. At this point, use the numeric keypad to input the value and select the desired unit from the unit menu that pops up, or use the direction keys and knob to modify the current value.

1. For the input method of the value, refer to the introduction in "[Parameter Setting Method](#)".
2. The edge time units available are sec, msec, μ sec and nsec.
3. The leading time and trailing time are independent from each other and users can set them separately.

5.2.9 Enable the Channel Output

After configuring the parameters of the waveform selected, waveform output could be enabled.

Press **[Output1]** or/and **[Output2]** button on the front panel and the backlight of the button turns on. The instrument outputs the configured waveform from the [Output1] or [Output2] connector on the front panel.

5.3 Basic Waveform Output Example

Configure the generator to output a pulse waveform with 1.5MHz frequency, 500mVpp amplitude, 5mV DC offset, 200ns pulse width, 75ns leading edge time and 100ns trailing edge time.

1. Press **[CH1/2]** button on the front panel and select CH1. The corresponding area of CH1 in the user interface is illuminated.
2. Press **[Wave]** > **Pulse** softkey to select the pulse wave function.
3. Press **Frequency** softkey to highlight it. Use the numeric keypad to input the frequency value "1.5", and then select the desired unit "MHz" from the pop-up menu.
4. Press **Amplitude** softkey to highlight it. Use the numeric keypad to input the amplitude value "500", and then select the desired unit "mVpp" in the pop-up menu.
5. Press **Offset** softkey to highlight it. Use the numeric keypad to input the offset value "5", and then select the desired unit "mV" in the pop-up menu.
6. Press **Width** softkey to highlight it. Use the numeric keypad to input the width value "200", then select the unit "nsec" from the menu that pops up.

7. Press **Edge Time** softkey to enter the edge time submenu. Press **Leading** softkey to highlight it. Use the numeric keypad to enter the value "75", then select the unit "nsec" from the menu that pops up.
8. Press **Edge Time** softkey to enter the edge time submenu. Press **Trailing** softkey to highlight it. Use the numeric keypad to enter the value "100", then select the unit "nsec" from the menu that pops up.
9. Press **[Output1]** button on the front panel to turn CH1 Output on.

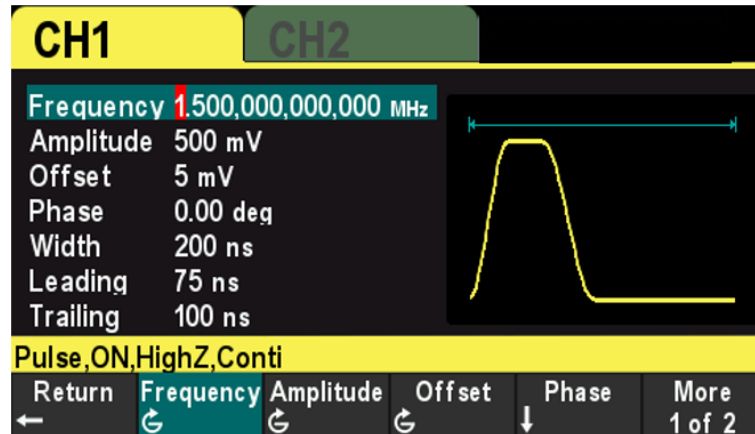

Figure 5.3 Setting Interface

At this point, the specified waveform is output from CH1 based on the current configuration. Connect the CH1 output terminal to the oscilloscope and the waveform is as shown in the figure below.

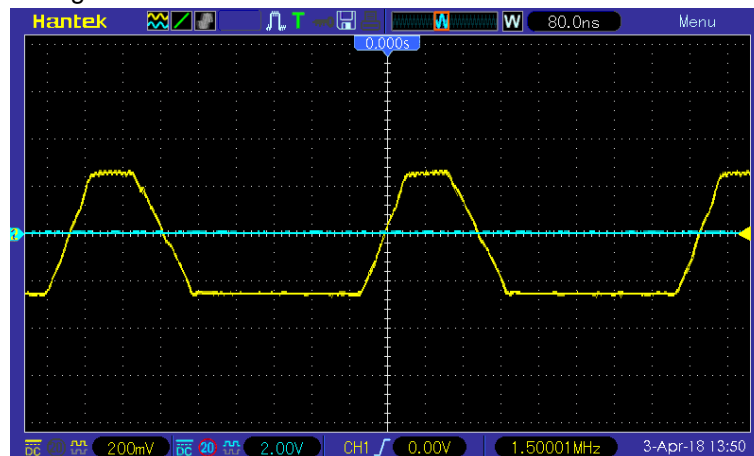

Figure 5.4 Output Waveform

6 Arbitrary Waveform Output

HDG3000B can output the built-in waveforms and user-defined arbitrary waveforms from a single channel or from two channels at the same time. The 160 kinds of built-in waveforms are stored in the internal non-volatile memory. The user-defined arbitrary waveforms can contain 64 to 2M data points. Users can edit the arbitrary waveforms via the PC software and then download them to the instrument.

This chapter introduces how to configure the generator to output arbitrary waveforms.

6.1 Enable Arbitrary Waveform

Press **[Wave]** > **Arb** softkey to enable the arbitrary waveform function and open the operation menu of the arbitrary waveform.

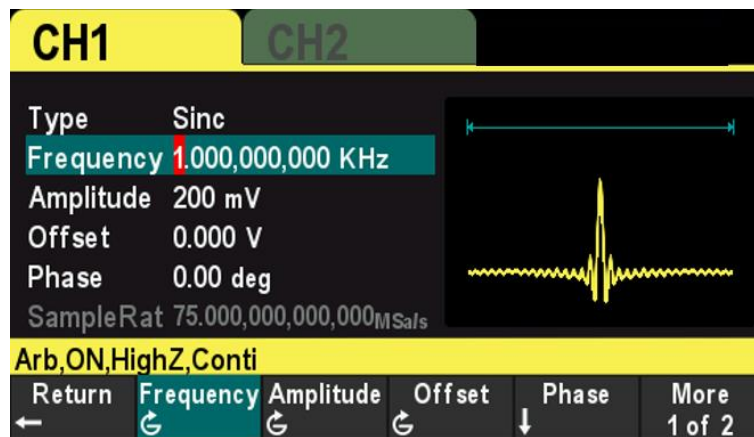

Figure 6.1 Arbitrary Interface

To set the basic parameters of arbitrary waveforms, refer to “Set the Parameters”.

Type:

Select the built-in waveforms or user-defined arbitrary waveform stored in external storage.

6.2 Select Arbitrary Waveform

The HDG3000B allows the user to select arbitrary waveform in the internal or external memory of the instrument for output.

Press **[Wave]** > **Arb** > **Type** softkey to select the built-in waveform.

Select more than 160 kinds of arbitrary waveform built in HDG3000B, as shown in the following table. Press the softkey and select a type ("Math", "Project", "Distribution function" and "Trigonometric function", "Window function" and "biology"), and press the corresponding softkey type to select the desired waveform.

Build-In Waveform

Name	Description
Common	
DC	DC signal
AbsSine	Absolute value of a Sine
AbsSineHalf	Absolute value of half a Sine
AmpALT	Gain oscillation curve
AttALT	Attenuation oscillation curve
GaussPulse	Gauss pulse
NegRamp	Negative ramp
NPulse	Negative pulse
PPulse	Positive pulse
SineTra	Sine-Tra waveform
SineVer	Sine-Ver waveform
StairDn	Stair-down waveform
StairUD	Stair-up and stair-down waveform
StairUp	Stair-up waveform
Trapezia	Trapezoid waveform
Project	
BandLimited	Bandwidth-limited signal
BlaseiWave	Time-velocity curve of explosive vibration
Butterworth	Butterworth filter
Chebyshev1	Chebyshev1 filter
Chebyshev2	Chebyshev2 filter
Combin	Combination function
CPulse	C pulse
CWPulse	CW pulse
DampedOsc	Time-displacement curve of damped oscillation
DualTone	Dual-tone signal
Gamma	Gamma signal
GateVibar	Gate self-oscillation signal
LFMPulse	Linear FM pulse
MCNoise	Mechanical construction noise
Discharge	Discharge curve of Ni-MH battery
Pahcur	Current waveform of DC brushless motor
Quake	Analog quake waveform
Radar	Analog radar waveform
Ripple	Ripple wave of battery
RoundHalf	RoundHalf wave
RoundsPM	RoundsPM waveform
StepResp	Step-response signal
SwingOsc	Kinetic energy- time curve of swing oscillation
TV	TV signal

Name	Description
Voice	Voice signal
Sec-Mod	
AM	Sectioned sine AM signal
FM	Sectioned sine FM signal
PFM	Sectioned pulse FM signal
PM	Sectioned sine PM signal
PWM	Sectioned PWM signal
Bioelect	
Cardiac	Cardiac signal
EOG	Electro-Oculogram
EEG	Electroencephalogram
EMG	Electromyogram
Pulseilogram	Pulsilogram
ResSpeed	Speed curve of the respiration
Medical	
LFPulse	Waveform of the low frequency pulse electrotherapy
Tens1	Waveform 1 of the nerve stimulation electrotherapy
Tens2	Waveform 2 of the nerve stimulation electrotherapy
Tens3	Waveform 3 of the nerve stimulation electrotherapy
Standard	
Ignition	Ignition waveform of the automotive motor
ISO16750-2 SP	Automotive starting profile with ringing
ISO16750-2 VR	Automotive supply voltage profile for resetting
ISO7637-2 TP1	Automotive transients due to disconnects
ISO7637-2 TP2A	Automotive transients due to inductance in wiring
ISO7637-2 TP2B	Automotive transients due ignition switching off
ISO7637-2 TP3A	Automotive transients due to switching
ISO7637-2 TP3B	Automotive transients due to switching
ISO7637-2 TP4	Automotive supply profile during starting
ISO7637-2 TP5A	Automotive transients due to battery disconnect
ISO7637-2 TP5B	Automotive transients due to battery disconnect
SCR	SCR firing profile
Surge	Surge signal
Math	
Airy	Airy function
Besselj	Bessell function
Bessely	Besselll function
Cauchy	Cauchy distribution function
Cubic	Cubic function
Dirichlet	Dirichlet function
Erf	Error function
Erfc	Complementary error function

Name	Description
ErfcInv	Inverted complementary error function
ErfInv	Inverted error function
ExpFall	Exponential fall function
ExpRise	Exponential rise function
Gauss	Gauss distribution
HaverSine	HaverSine function
Laguerre	4-times Laguerre polynomial
Laplace	Laplace distribution
Legend	5-times Legend polynomial
Log	Logarithm function with the base 10
LogNormal	Logarithmic Gaussian distribution
Lorentz	Lorentz function
Maxwell	Maxwell distribution
Rayleigh	Rayleigh distribution
Versiera	Versiera
Weibull	Weibull distribution
ARB_X2	Square function
Trigonome	
CosH	Hyperbolic cosine
CosInt	Integral cosine
Cot	Cotangent
CotHCon	Concave hyperbolic cotangent
CotHPro	Protuberant hyperbolic cotangent
CscCon	Concave cosecant
CscPro	Protuberant cosecant
CscHCon	Concave hyperbolic cosecant
CscHPro	Protuberant hyperbolic cosecant
RecipCon	Concave reciprocal
RecipPro	Protuberant reciprocal
SecCon	Concave secant
SecPro	Protuberant secant
SecH	Hyperbolic secant
Sinc	Sinc function
SinH	Hyperbolic sine
SinInt	Integral sine
Sqrt	Square root
Tan	Tangent
TanH	Hyperbolic tangent
Anti Trigonome	
ACos	Arc cosine
ACosH	Arc hyperbolic cosine

Name	Description
ACotCon	Concave arc cotangent
ACotPro	Protuberant arc cotangen
ACotHCon	Concave arc hyperbolic cotangent
ACotHPro	Protuberant arc hyperbolic cotangent
ACscCon	Concave arc cosecant
ACscPro	Protuberant arc cosecant
ACscHCon	Concave arc hyperbolic cosecant
ACscHPro	Protuberant arc hyperbolic cosecant
ASecCon	Concave arc secant
ASecPro	Protuberant arc secant
ASecH	Arc hyperbolic secant
ASin	Arc Sinc
ASinH	Arc hyperbolic sine
ATan	Arc tangent
ATanH	Arc hyperbolic tangent
Window	
Bartlett	Bartlett window
BarthannWin	Modified Bartlett-Hann window
Blackman	Blackman window
BlackmanH	BlackmanH window
BohmanWin	Bohman window
Boxcar	Rectangle window
ChebWin	Chebyshev window
FlattopWin	Flat Top weighted window
Hamming	Hamming window
Hanning	Hanning window
Kaiser	Kaiser window
NuttallWin	Nuttall-defined minimum 4-term Blackman-Harris window
ParzenWin	Parzen window
TaylorWin	Taylor window
Triang	Triangle window (Fejer window)
TukeyWin	Tukey (tapered cosine) window

Table 6.1 Build-In waveform

User-defined Waveforms

Select the user-defined arbitrary waveform stored in external storage (USB drive).

Loading arbitrary waveform

Edit the ARB waveform by PC software and export the waveform data to the external storage device as .hwf file.

Press **[Wave]** > **Arb** softkey to enter the arbitrary menu, and press **Type** > **User** softkey to select the arbitrary waveform file to load.

7 Harmonic Output

The HDG3000B can be used as a harmonic generator to output harmonic with specified order, amplitude and phase. It is usually used in the test of harmonic detector device or harmonic filter device.

This chapter introduces how to configure the generator to output harmonics. Subjects in this chapter:

7.1 Overview

According to Fourier transform, time domain waveform is the superposition of a series of sine waveforms as shown in the equation below:

$$f(t) = A_1 \sin(2\pi f_1 t + \varphi_1) + A_2 \sin(2\pi f_2 t + \varphi_2) + A_3 \sin(2\pi f_3 t + \varphi_3) + \dots$$

Generally, component with f_1 frequency is called basic waveform, f_1 is basic waveform frequency, A_1 is basic waveform amplitude and φ_1 is basic waveform phase. The frequencies of other components (called harmonics) are all integral multiples of the basic waveform frequency. Components whose frequencies are odd multiples of the basic waveform frequency are odd harmonics and components whose frequencies are even multiples of the basic waveform frequency are even harmonics.

HDG3000B can output up to 16th order of harmonic. After selecting CH1 or CH2, press **[Wave] > Harmonic** softkey on the front panel to enter the harmonic setting menu.

Users can set the parameters of basic waveform, set the type of harmonic, specify the highest order of harmonic and set the amplitude and phase of each order of harmonic.

After finishing harmonic parameter setting, press **[Output1]** button or (and) **[Output2]** button on the front panel and the backlight of the button turns on, the instrument outputs the specified harmonic from the corresponding output terminal.

7.2 Set the Basic Waveform Parameters

Users can set various basic waveform parameters such as frequency, period, amplitude, DC offset voltage, high level, low level and start phase. It also supports synchronizing phase operation. Please refer to introductions in "[Basic Waveform Output](#)" to set basic waveform parameters.

7.3 Set the Harmonic Order

The highest order of harmonic output cannot be greater than this setting value.

Press **[Wave] > Harmonic** softkey on the front panel to enter the harmonic setting menu, and press **Order** softkey, at this time, the "Order" on the screen is highlighted, use the numeric keypad or the direction keys and the knob to input the corresponding

value. The range is limited by the maximum output frequency of the instrument as well as the basic waveform frequency.

- Range: integers within 2 to maximum output frequency of the instrument \div basic waveform frequency.
- The maximum value is 16.

7.4 Set the Harmonic Type

HDG3000B can output even harmonics, odd harmonics or all orders of harmonics. Press **[Wave]** > **Harmonic** softkey on the front panel to enter the harmonic setting menu, and press **Type** softkey to select the desired harmonic type.

1. **Even**

Select this type and the instrument would output basic waveform and even harmonics.

2. **Odd**

Select this type and the instrument would output basic waveform and odd harmonics.

3. **All**

Select this type and the instrument would output basic waveform and all the harmonics in order.

Note: The harmonics actually output is determined by the "Order" currently specified.

7.5 Set the Harmonic Amplitude

Press **[Wave]** > **Harmonic** softkey to enter the harmonic setting menu and press **Amplitude** softkey to set the amplitude of each harmonic.

1. **Index:**

Press this softkey to select the index number of the harmonic to be selected.

2. **Amplitude:**

Press this softkey to set the amplitude of the selected subharmonic. Use the numeric keypad to input the amplitude value and then select the desired unit from the pop-up menu, or use the direction keys and knob to modify the current value.

- For the input method of amplitude value, please refer to the introduction in "Parameter Setting Method".
- The amplitude units available are Vpp and mVpp.

7.6 Set the Harmonic Phase

Press **[Wave]** > **Harmonic** softkey to enter the harmonic setting menu and press **Phase** softkey to set the phase of each harmonic.

1. **Index:**

Press this softkey to select the index number of the harmonic to be selected.

2. **Phase:**

Press this softkey to set the phase of the selected subharmonic. Use the numeric keypad to input the phase value and then select the unit "°" from the pop-up menu, or use the direction keys and knob to modify the current value. For the input method of phase value, refer to the introduction in "[Parameter Setting Method](#)".

8 Modulation

HDG3000B supports AM, DSB-AM, FM, PM, 2ASK, 2FSK, 2PSK, BPSK, QPSK, 3FSK, 4FSK, OSK and PWM modulations. It can output modulated waveform from a single channel or from two channels at the same time. The modulated waveform consists of carrier waveform and modulating waveform. The carrier waveform can be Sine, Square, Ramp, Pulse, Arbitrary waveform (except DC) or Harmonic. The modulating waveform can be from internal (default), other channel, or external modulation source.

8.1 AM Modulation

A modulated waveform consists of a carrier waveform and a modulating waveform. In AM, the carrier amplitude is varied by the voltage level of the modulating waveform.

8.1.1 Select AM Modulation

Press **[Mod]** > **Type** > **AM** softkey to enable AM function.

- When **Mod** is enabled, **Sweep** or **Burst** will be disabled automatically.
- After AM is enabled, the instrument will generate AM waveform with the currently specified carrier and modulating waveforms. To avoid multiple waveform changes, enable modulation after configuring the other modulation parameters.

8.1.2 Carrier Waveform Shape

AM carrier shape: Sine (default), Square, Ramp, Pulse, Arbitrary (except DC) or Harmonic waveform.

- Press **[Wave]** button on the front panel to select the desired carrier waveform shape.
- Noise and DC could not be used as carrier waveform.

8.1.3 Carrier Waveform Frequency

For different carrier waveforms, the settable range of carrier frequency is different. Please refer to "Frequency Characteristics" in Specifications. The default value is 1kHz. Press **[Setting]** > **Frequency** softkey on the front panel, and then use the numeric keypad or direction keys and knob to input the desired frequency value.

8.1.4 Modulation Source

Press **[Mod]** > **SignalSrc** softkey to select internal, external or another ch as the

modulation source.

Internal Source

When internal modulation source is selected, press **Shape** softkey to select Sine, Square, Ramp, Noise or Arb as the modulation source. The default is Sine.

- Sine
- Square: 50% duty cycle
- Ramp: 50% symmetry.
- Noise
- Arb: Sinc, Exp Fall, Haver Sine, Lorentz, Gause, Dual Tone, ECG.

Note: Noise can be used as modulating waveform but cannot be used as carrier waveform.

External Source

When external modulation source is selected, the **Frequency** and **Shape** menu in the modulation menu is grayed out and disabled. The instrument receives the external modulation signal from the **[FSK/Trig/Sync/Extmod]** connector on the rear panel. At this point, the AM modulation amplitude is controlled by the $\pm 4V$ signal level on this connector. For example, when the modulation depth is 100%, the output amplitude is maximum when the external modulation signal is +4V, and the output amplitude is the minimum when the external modulation signal is -4V.

Other Channels

CH1 and CH2 can be used as modulation sources reciprocally. When CH1 is used as the modulated wave, CH2 can be used as the modulation source. And vice versa. When selecting another channel as the modulation source, please turn on the output of that channel.

8.1.5 Modulation Frequency

When internal modulation source is selected, press **[Mod] > Frequency** softkey to set the frequency of the modulating waveform.

Use the numeric keypad or direction keys and knob to enter the desired frequency values.

The modulating waveform frequency range is 2mHz to 1MHz, and the default value is 100Hz.

Note: This menu will be grayed out and disabled when other modulation sources except the internal modulation source are selected.

8.1.6 Modulation Depth

The modulation depth is a percentage that represents the amplitude variation.

Press **[Mod] > Depth** softkey to set AM modulation depth.

Modulation depth range: 0% to 120%. The default is 100%.

At 0% depth, the amplitude is one-half of the carrier's amplitude setting.

At 100% depth, the output amplitude is equal to the specified value.

In >100% modulation, the output amplitude of the instrument would not exceed 10Vpp (50Ω load).

When external modulation source is select, the output amplitude of the instrument is also controlled by the ±4V signal level on the **[FSK/Trig/Sync/Extmod]** connector on the rear panel. For example, set the modulation depth to 100%, the output amplitude is the maximum when the modulating signal is +4V and the minimum when the modulating signal is -4V.

8.2 DSB-AM Modulation

In the Double-sideband AM signal, there are only two side frequencies, and there is no carrier component. Its frequency bandwidth is still twice the frequency of the modulated signal.

8.2.1 Select DSB-AM Modulation

Press **[Mod] > Type > DSB-AM** softkey to enable DSB-AM function.

- When **Mod** is enabled, **Sweep** or **Burst** will be disabled automatically.
- After DSB-AM is enabled, the instrument will generate DSB-AM waveform with the currently specified carrier and modulating waveforms. To avoid multiple waveform changes, enable modulation after configuring the other modulation parameters.

8.2.2 Carrier Waveform Shape

DSB-AM carrier shape: Sine (default), Square, Ramp, Pulse, Arbitrary (except DC) or Harmonic waveform.

- Press **[Wave]** button on the front panel to select the desired carrier waveform.
- Noise and DC could not be used as carrier waveform.

8.2.3 Carrier Waveform Frequency

For different carrier waveforms, the settable range of carrier frequency is different. please refer to "Frequency Characteristics" in Specifications. The default value is 1kHz.

Press **[Setting]** > **Frequency** softkey on the front panel, and then use the numeric keypad or direction keys and knob to input the desired frequency value.

8.2.4 Modulation Source

Press **[Mod]** > **SignalSrc** softkey to select Internal, External or Another Channel as the modulation source.

internal Source

When internal modulation source is selected, press **Shape** softkey to select Sine, Square, Ramp, Noise or Arb as the modulation source. The default is Sine.

- Sine
- Square: 50% duty cycle
- Ramp: 50% symmetry.
- Noise
- Arb: Sinc, Exp Fall, Haver Sine, Lorentz, Gause, Dual Tone, ECG.

Note: Noise can be used as modulating waveform but cannot be used as carrier waveform.

external Source

When external modulation source is selected, the **Frequency** and **Shape** menu in the modulation menu is grayed out and disabled. The instrument receives the external modulation signal from the **[FSK/Trig/Sync/Extmod]** connector on the rear panel. At this point, the AM modulation amplitude is controlled by the $\pm 4V$ signal level on this connector. For example, when the modulation depth is 100%, the output amplitude is maximum when the external modulation signal is +4V, and the output amplitude is the minimum when the external modulation signal is -4V.

another ch

CH1 and CH2 can be used as modulation sources reciprocally. When CH1 is used as the modulated wave, CH2 can be used as the modulation source. And vice versa. When selecting another channel as the modulation source, please turn on the output of that channel.

8.2.5 Modulation Frequency

When internal modulation source is selected, press **[Mod]** > **Frequency** softkey to set the frequency of the modulating waveform.

- Use the numeric keypad or direction keys and knob to enter the desired frequency values.
- The modulating waveform frequency range is 2mHz to 1MHz, and the default value

is 100Hz.

Note: This menu will be grayed out and disabled when other modulation sources except the internal modulation source are selected.

8.2.6 Modulation Depth

The modulation depth represents the degree of amplitude variation, expressed as a percentage. The modulation depth of DSB-AM can be set from 0% to 120%.

- Press **[Mod] > Depth** softkey to set DSB-AM modulation depth.
- Modulation depth range: 0% to 120%. The default is 100%.
- At 0% modulation, no signal is output.
- At 50% depth, the DSB-AM amplitude is 1/4 of the carrier waveform amplitude.
- At 100% depth, the DSB-AM amplitude is half of the carrier waveform amplitude.
- In >100% modulation, the DSB-AM amplitude of the instrument would not exceed 10Vpp (50Ω load).

When external modulation source is select, the output amplitude of the instrument is also controlled by the ±4V signal level on the **[FSK/Trig/Sync/Extmod]** connector on the rear panel. For example, set the modulation depth to 100%, the output amplitude is the maximum when the modulating signal is +4V or -4V, and the output amplitude is the minimum when the modulating signal is 0V.

8.3 FM Modulation

A modulated waveform consists of a carrier waveform and a modulating waveform. In FM, the carrier frequency is varied by the voltage level of the modulating waveform.

8.3.1 Select FM Modulation

Press **[Mod] > Type > FM** softkey to enable FM function.

- When **Mod** is enabled, **Sweep** or **Burst** will be disabled automatically.
- After FM is enabled, the instrument will generate FM waveform with the currently specified carrier and modulating waveforms. To avoid multiple waveform changes, enable modulation after configuring the other modulation parameters.

8.3.2 Carrier Waveform Shape

FM carrier shape: Sine (default), Square, Ramp, Pulse, Arbitrary (except DC) or Harmonic waveform.

- Press **[Wave]** button on the front panel to select the desired carrier waveform.

- Noise and DC could not be used as carrier waveform.

8.3.3 Carrier Waveform Frequency

For different carrier waveforms, the settable range of carrier frequency is different. please refer to "Frequency Characteristics" in Specifications. The default value is 1kHz. Press **[Setting] > Frequency** softkey on the front panel, and then use the numeric keypad or direction keys and knob to input the desired frequency value.

8.3.4 Modulation Source

Press **[Mod] > SignalSrc** softkey to select Internal, External or Another Channel as the modulation source.

internal Source

When internal modulation source is selected, press **Shape** softkey to select Sine, Square, Ramp, Noise or Arb as the modulation source. The default is Sine.

- Sine
- Square: 50% duty cycle
- Ramp: 50% symmetry.
- Noise
- Arb: Sinc, Exp Fall, Haver Sine, Lorentz, Gause, Dual Tone, ECG.

Note: Noise can be used as modulating waveform but cannot be used as carrier waveform.

external source

When external modulation source is selected, the Frequency and Shape menu in the modulation menu is grayed out and disabled. The instrument receives the external modulation signal from the **[FSK/Trig/Sync/Extmod]** connector on the rear panel. At this point, the FM modulation frequency deviation is controlled by the $\pm 4V$ signal level on the connector.

another ch

CH1 and CH2 can be used as modulation sources reciprocally. When CH1 is used as the modulated wave, CH2 can be used as the modulation source. And vice versa. When selecting another channel as the modulation source, please turn on the output of that channel.

8.3.5 Modulation Frequency

When internal modulation source is selected, press **[Mod] > Frequency** softkey to set the frequency of the modulating waveform.

- Use the numeric keypad or direction keys and knob to enter the desired frequency values.
- The modulating waveform frequency range is 2mHz to 1MHz, and the default value is 100Hz.

Note: This menu will be grayed out and disabled when other modulation sources except the internal modulation source are selected.

8.3.6 Frequency Deviation

Frequency deviation is the deviation of the modulating waveform frequency relative to the carrier frequency. Press **[Mod] > Deviation** softkey to set the FM frequency deviation.

- Frequency deviation must be lower than or equal to the carrier frequency.
- Attempting to set a deviation greater than the carrier frequency will cause the instrument to set the deviation equal to the carrier frequency.
- The sum of frequency deviation and carrier frequency must be lower than or equal to the sum of the current carrier frequency upper limit and 1kHz.

When external modulation source is selected, the frequency deviation is controlled by the $\pm 4V$ signal level on the **[FSK/Trig/Sync/Extmod]** connector on the rear panel. Positive signal level corresponds to frequency increase and negative signal level corresponds to frequency decrease. The lower the level, the less offset is generated. For example, if the frequency deviation is set to 1kHz, +4V signal level corresponds to a 1kHz increase of frequency and -4V signal level corresponds to a 1kHz decrease of frequency.

8.4 PM Modulation

A modulated waveform consists of a carrier waveform and a modulating waveform. In PM, the carrier phase is varied by the voltage level of the modulating waveform.

8.4.1 Select PM Modulation

Press **[Mod] > Type > PM** softkey to enable PM function.

- When **Mod** is enabled, **Sweep** or **Burst** will be disabled automatically.

- After PM is enabled, the instrument will generate PM waveform with the currently specified carrier and modulating waveforms. To avoid multiple waveform changes, enable modulation after configuring the other modulation parameters.

8.4.2 Carrier Waveform Shape

PM carrier shape: Sine (default), Square, Ramp, Pulse, Arbitrary (except DC) or Harmonic waveform.

- Press **[Wave]** button on the front panel to select the desired carrier waveform.
- Noise and DC could not be used as carrier waveform.

8.4.3 Carrier Waveform Frequency

For different carrier waveforms, the settable range of carrier frequency is different. please refer to "Frequency Characteristics" in Specifications. The default value is 1kHz. Press **[Setting] > Frequency** softkey on the front panel, and then use the numeric keypad or direction keys and knob to input the desired frequency value.

8.4.4 Modulation Source

Press **[Mod] > SignalSrc** softkey to select Internal, External or Another Channel as the modulation source.

internal Source

When internal modulation source is selected, press **Shape** softkey to select Sine, Square, Ramp, Noise or Arb as the modulation source. The default is Sine.

- Sine
- Square: 50% duty cycle
- Ramp: 50% symmetry.
- Noise
- Arb: Sinc, Exp Fall, Haver Sine, Lorentz, Gause, Dual Tone, ECG.

Note: Noise can be used as modulating waveform but cannot be used as carrier waveform.

external Source

When external modulation source is selected, the **Frequency** and **Shape** menu in the modulation menu is grayed out and disabled. The instrument receives the external modulation signal from the **[FSK/Trig/Sync/Extmod]** connector on the rear panel. At this point, the PM modulation phase deviation is controlled by the $\pm 4V$ signal level on the connector.

another ch

CH1 and CH2 can be used as modulation sources reciprocally. When CH1 is used as the modulated wave, CH2 can be used as the modulation source. And vice versa. When selecting another channel as the modulation source, please turn on the output of that channel.

8.4.5 Modulation Frequency

When internal modulation source is selected, press **[Mod]** > **Frequency** softkey to set the frequency of the modulating waveform.

- Use the numeric keypad or direction keys and knob to enter the desired frequency values.
- The modulating waveform frequency range is 2mHz to 1MHz, and the default value is 100Hz.

Note: This menu will be grayed out and disabled when other modulation sources except the internal modulation source are selected.

8.4.6 Phase Deviation

Phase deviation is the deviation of the modulating waveform phase relative to the carrier waveform phase. Press **[Mod]** > **Deviation** softkey to set the PM phase deviation.

- Use the numeric keypad or direction keys and knob to input the desired phase values.
- The phase deviation is set to 0 ° to 360 °.

When external modulation source is selected, the phase deviation is controlled by the $\pm 4V$ signal level on the **[FSK/Trig/Sync/Extmod]** connector on the rear panel. For example, if the phase deviation is set to 180 °, +4V signal level corresponds to a 180° phase variation. The lower the external signal level, the less deviation would be generated.

8.5 ASK Modulation

Users can configure the instrument to "shift" its output amplitude between two preset values using ASK modulation. The rate at which the output shifts between the two amplitudes (called the "carrier amplitude" and the "modulation amplitude") is determined by the internal signal level of the instrument or the external signal level on the **[FSK/Trig/Sync/Extmod]** connector on the rear panel.

8.5.1 Select ASK modulation

Press **[Mod]** > **Type** > **ASK** softkey to enable this function.

- When **Mod** is enabled, **Sweep** or **Burst** will be disabled automatically.
- After ASK is enabled, the instrument will generate ASK waveform with the currently specified carrier and modulating waveforms. To avoid multiple waveform changes, enable modulation after configuring the other modulation parameters.

8.5.2 Carrier Waveform Shape

ASK carrier shape: Sine (default), Square, Ramp, Pulse, Arbitrary (except DC) or Harmonic waveform.

- Press **[Wave]** button on the front panel to select the desired carrier waveform.
- Noise and DC could not be used as carrier waveform.

8.5.3 Carrier Waveform Amplitude

After selecting the carrier waveform, press **[Setting]** > **Amplitude** softkey on the front panel, use the numeric keypad or direction keys and knob to input the desired amplitude. The amplitude range is limited by frequency. Please refer to the "Output Characteristics" described in Specifications.

8.5.4 Modulation Source

Press **[Mod]** > **SignalSrc** to select Internal or External Modulation Source.

internal Source

When internal modulation source is selected, the modulating waveform is set as a Square with 50% duty cycle, and the rate at which the output amplitude "shifts" between "carrier amplitude" and "modulating amplitude" is determined by "ASK Rate".

external Source

When external modulation source is selected, the generator receives the external modulating signal from the **[FSK/Trig/Sync/Extmod]** connector on the rear panel.

Note: The [FSK/Trig/Sync/Extmod] connector is different when controlling ASK and AM/FM/PM modulations externally.

8.5.5 ASK Rate

When internal modulation source is selected, press **[Mod] > Rate** softkey to set the rate at which the output amplitude shifts between "carrier amplitude" and "modulation amplitude".

- Use the numeric keypad or direction keys and knob to input the desired rate value.
- The rate range is from 2mHz to 1MHz and the default is 100Hz.

Note: This menu will be grayed out and disabled when the external modulation source is selected.

8.5.6 Modulation Amplitude

After enabling ASK modulation function, press **[Mod] > Amplitude** softkey to set the modulation amplitude.

- Use the numeric keypad or direction keys and knob to input the desired amplitude value.
- The range of amplitude (HighZ) is from 2mV to 20V and the default is 100mV.

8.6 FSK Modulation

Users can configure the instrument to "shift" its output frequency between two preset values using FSK modulation. The rate at which the output shifts between the two frequencies (called the "carrier frequency" and the "hop frequency") is determined by the internal signal level of the instrument or the signal level on the **[FSK/Trig/Sync/Extmod]** connector on the rear panel.

8.6.1 Select FSK Modulation

Press **[Mod] > Type > FSK** softkey to enable FSK function.

- When **Mod** is enabled, **Sweep** or **Burst** will be disabled automatically.
- After FSK is enabled, the instrument will generate FSK waveform with the currently specified carrier and modulating waveforms. To avoid multiple waveform changes, enable modulation after configuring the other modulation parameters.

8.6.2 Carrier Waveform Shape

FSK carrier shape: Sine (default), Square, Ramp, Pulse, Arbitrary (except DC) or Harmonic waveform.

- Press **[Wave]** button on the front panel to select the desired carrier waveform.
- Noise and DC could not be used as carrier waveform.

8.6.3 Carrier Waveform Frequency

For different carrier waveforms, the settable range of carrier frequency is different. please refer to "Frequency Characteristics" in Specifications. The default value is 1kHz. Press **[Setting] > Frequency** softkey on the front panel, and then use the numeric keypad or direction keys and knob to input the desired frequency value.

8.6.4 Modulation Source

Press **[Mod] > SignalSrc** softkey to select Internal (default) or External as the modulation source.

internal Source

When internal modulation source is selected, the modulating waveform is set as a Square with 50% duty cycle, and the rate at which the output frequency "shifts" between "carrier frequency" and "modulating frequency" is determined by "FSK Rate".

external Source

When external modulation source is selected, the generator receives the external modulating signal from the **[FSK/Trig/Sync/Extmod]** connector on the rear panel.

Note: The [FSK/Trig/Sync/Extmod] connector is different when controlling FSK and

AM/FM/PM modulations externally.

8.6.5 FSK Rate

When internal modulation source is selected, press **[Mod] > Rate** softkey to set the rate at which the output frequency shifts between "carrier frequency" and "hopping frequency".

- Use the numeric keypad or direction keys and knob to input the desired rate value.
- The rate range is from 2mHz to 1MHz and the default is 100Hz.

Note: This menu will be grayed out and disabled when the external modulation source is selected.

8.6.6 Hopping Frequency

The range of hopping frequency depends on the carrier waveform currently selected.

Refer to "Frequency Characteristics" in Specifications.

Press **[Mod]** > **HopFreq** softkey. Use the numeric keypad or direction keys and knob to input the desired frequency value.

8.7 PSK Modulation

Users can configure the instrument to "shift" its output phase between two preset values using PSK modulation. The rate at which the output shifts between the two phases (called the "carrier phase" and the "modulation phase") is determined by the internal signal level of the instrument or the signal level on the **[FSK/Trig/Sync/Extmod]** connector on the rear panel.

8.7.1 Select PSK Modulation

Press **[Mod]** > **Type** > **PSK** softkey to enable PSK function.

- When **Mod** is enabled, **Sweep** or **Burst** will be disabled automatically.
- After PSK is enabled, the instrument will generate PSK waveform with the currently specified carrier and modulating waveforms. To avoid multiple waveform changes, enable modulation after configuring the other modulation parameters.

8.7.2 Carrier Waveform Shape

PSK carrier shape: Sine (default), Square, Ramp, Pulse, Arbitrary (except DC) or Harmonic waveform.

- Press **[Wave]** button on the front panel to select the desired carrier waveform.
- Noise and DC could not be used as carrier waveform.

8.7.3 Carrier Waveform Phase

Press **[Setting]** > **Phase** softkey on the front panel and use the numeric keypad or direction keys and knob to input the desired phase.

The available phase ranges from 0° to 360° and the default value is 0°.

8.7.4 Modulation Source

Press **[Mod]** > **SignalSrc** to select Internal or External modulation source.

internal Source

When internal modulation source is selected, the modulating waveform is set as a Square with 50% duty cycle, and the rate at which the output phase "shifts" between "carrier phase" and "modulation phase" is determined by "PSK Rate".

external source

When external modulation source is selected, the generator receives the external modulating signal from the **[FSK/Trig/Sync/Extmod]** connector on the rear panel.

Note: The [FSK/Trig/Sync/Extmod] connector is different when controlling PSK and AM/FM/PM modulations externally.

8.7.5 PSK Rate

When internal modulation source is selected, press **[Mod]** > **Rate** softkey to set the rate at which the output phase shifts between "carrier phase" and "modulation phase".

- Use the numeric keypad or direction keys and knob to input the desired rate value.
- The rate range is from 2mHz to 1MHz and the default is 100Hz.

Note: This menu will be grayed out and disabled when the external modulation source is selected.

8.7.6 Modulation Phase

Press **[Mod]** > **Phase** softkey to set the modulation phase.

- Use the numeric keypad or direction keys and knob to input the desired phase value.
- The phase range is from 0° to 360° and the default is 180°.

8.8 BPSK Modulation

Users can configure the instrument to "shift" its output phase between two preset values using BPSK modulation. The rate at which the output shifts between the two phases (called the "carrier phase" and the "modulation phase") is determined by the internal signal level of the instrument.

8.8.1 Select BPSK Modulation

Press **[Mod]** > **Type** > **BPSK** softkey to enable the BPSK function.

- When **Mod** is enabled, **Sweep** or **Burst** will be disabled automatically.
- After BPSK is enabled, the instrument will generate BPSK waveform with the currently specified carrier and modulating waveforms. To avoid multiple waveform changes, enable modulation after configuring the other modulation parameters.

8.8.2 Carrier Waveform Shape

BPSK carrier shape: Sine (default), Square, Ramp, Pulse, Arbitrary (except DC) or Harmonic waveform.

- Press **[Wave]** button on the front panel to select the desired carrier waveform.
- Noise and DC could not be used as carrier waveform.

8.8.3 Carrier Waveform Phase

Press **[Setting]** > **Phase** softkey on the front panel and use the numeric keypad or direction keys and knob to input the desired phase.

The available phase ranges from 0° to 360° and the default value is 0°.

8.8.4 Modulation Source

BPSK uses internal modulation source. After enabling BPSK modulation function, press **[Mod]** > **Data Source** softkey, and select 01 code, 10 code, PN15 code or PN21 code as the modulation source. The default data source is 01 code.

8.8.5 BPSK Rate

When internal modulation source is selected, press **[Mod]** > **Rate** softkey to set the rate at which the output phase shifts between "carrier phase" and "modulation phase".

- Use the numeric keypad or direction keys and knob to input the desired rate value.
- The rate range is from 2mHz to 1MHz and the default is 100Hz.

8.8.6 Modulation Phase

Pressing **[Mod]** > **Phase** softkey to set the modulation phase.

- Use the numeric keypad or direction keys and knob to input the desired phase values.

- The phase range is from 0° to 360° and the default is 180°.

8.9 QPSK Modulation

Users can configure the instrument to "shift" its output phase between four preset values using QPSK modulation. The rate at which the output shifts between the four phases (called the "carrier phase" and three "modulation phases") is determined by the internal signal level of the instrument.

8.9.1 Select QPSK Modulation

Press **[Mod]** > **Type** > **QPSK** softkey to enable QPSK function.

- When **Mod** is enabled, **Sweep** or **Burst** will be disabled automatically.
- After QPSK is enabled, the instrument will generate QPSK waveform with the currently specified carrier and modulating waveforms. To avoid multiple waveform changes, enable modulation after configuring the other modulation parameters.

8.9.2 Carrier Waveform Shape

QPSK carrier shape: Sine (default), Square, Ramp, Pulse, Arbitrary (except DC) or Harmonic waveform.

- Press **[Wave]** button on the front panel to select the desired carrier waveform.
- Noise and DC could not be used as carrier waveform.

8.9.3 Carrier Waveform Phase

Press **[Setting]** > **Phase** softkey on the front panel and use the numeric keypad or direction keys and knob to input the desired phase.

The available phase ranges from 0° to 360° and the default value is 0°.

8.9.4 Modulation Source

QPSK uses the internal modulation source. After enabling QPSK modulation function, press **[Mod]** > **Data Source** softkey, and select PN15 and PN21 codes as the modulation source. The default is PN15 code.

8.9.5 QPSK Rate

When internal modulation source is selected, press **[Mod]** > **Rate** softkey to set the rate at which the output phase shifts between "carrier phase" and three "modulation

phases".

- Use the numeric keypad or direction keys and knob to input the desired rate value.
- The rate range is from 2mHz to 1MHz and the default is 100Hz.

8.9.6 Modulation Phase

Press **[Mod]** > **Phase1** or **Phase2/Phase3** softkeys to set the parameter.

- Use the numeric keypad or direction keys and knob to input the desired amplitude value.
- The phase range is from 0° to 360°. The default is 180°. The default values for phases 1, 2, and 3 are 45°, 135°, and 225°, respectively.

8.10 3FSK Modulation

Users can configure the instrument to "shift" its output frequency between three preset values using 3FSK modulation. The rate at which the output shifts between the three frequencies (called the "carrier frequency" and two "hop frequencies") is determined by the internal signal level of the instrument.

8.10.1 Select 3FSK Modulation

Press **[Mod]** > **Type** > **3FSK** softkey to enable 3FSK function.

- When **Mod** is enabled, **Sweep** or **Burst** will be disabled automatically.
- After 3FSK is enabled, the instrument will generate 3FSK waveform with the currently specified carrier and modulating waveforms. To avoid multiple waveform changes, enable modulation after configuring the other modulation parameters.

8.10.2 Carrier Waveform Shape

3FSK carrier shape: Sine (default), Square, Ramp, Pulse, Arbitrary (except DC) or Harmonic waveform.

- Press **[Wave]** button on the front panel to select the desired carrier waveform.
- Noise and DC could not be used as carrier waveform.

8.10.3 Carrier Waveform Frequency

For different carrier waveforms, the settable range of carrier frequency is different. please refer to "Frequency Characteristics" in Specifications. The default value is 1kHz. Press **[Setting]** > **Frequency** softkey on the front panel, and then use the numeric keypad or direction keys and knob to input the desired frequency value.

8.10.4 Modulation Source

3FSK uses internal modulation source. The modulating waveform is square.

8.10.5 3FSK Rate

When internal modulation source is selected, press **[Mod] > Rate** softkey to set the rate at which the output frequency shifts between "carrier frequency" and two "hopping frequencies".

- Use the numeric keypad or direction keys and knob to input the desired rate value.
- The rate range is from 2mHz to 1MHz and the default is 100Hz.

8.10.6 Hopping Frequency

The range of hopping frequency depends on the carrier waveform currently selected. Refer to "Frequency Characteristics" in Specifications.

Press **[Mod] > HopFreq** softkey. Use the numeric keypad or direction keys and knob to input the desired frequency value.

8.11 4FSK Modulation

Users can configure the instrument to "shift" its output frequency between four preset values using 4FSK modulation. The rate at which the output shifts between the four frequencies (called the "carrier frequency" and three "hop frequencies") is determined by the internal signal level of the instrument.

8.11.1 Select 4FSK Modulation

Press **[Mod] > Type > 4FSK** softkey to enable 4FSK function.

- When **Mod** is enabled, **Sweep** or **Burst** will be disabled automatically.
- After 4FSK is enabled, the instrument will generate 4FSK waveform with the currently specified carrier and modulating waveforms. To avoid multiple waveform changes, enable modulation after configuring the other modulation parameters.

8.11.2 Carrier Waveform Shape

4FSK carrier shape: Sine (default), Square, Ramp, Pulse, Arbitrary (except DC) or Harmonic waveform.

- Press **[Wave]** button on the front panel to select the desired carrier waveform.
- Noise and DC could not be used as carrier waveform.

8.11.3 Carrier Waveform Frequency

For different carrier waveforms, the settable range of carrier frequency is different. please refer to "Frequency Characteristics" in Specifications. The default value is 1kHz. Press **[Setting] > Frequency** softkey on the front panel, and then use the numeric keypad or direction keys and knob to input the desired frequency value.

8.11.4 Modulation Source

4FSK uses internal modulation source. The modulating waveform is square.

8.11.5 4FSK Rate

When internal modulation source is selected, press **[Mod] > Rate** softkey to set the rate at which the output frequency shifts between "carrier frequency" and three "hopping frequencies".

- Use the numeric keypad or direction keys and knob to input the desired rate value.
- The rate range is from 2mHz to 1MHz and the default is 100Hz.

8.11.6 Hopping Frequency

The range of hopping frequency depends on the carrier waveform currently selected. Refer to "Frequency Characteristics" in Specifications.

Press **[Mod] > HopFreq** softkey. Use the numeric keypad or direction keys and knob to input the desired frequency value.

8.12 OSK Modulation

When OSK (Oscillation Shift Keying) modulation is selected, users can configure the generator to output a sine signal with intermittent oscillation as shown in the figure below (the carrier waveform is 100Hz and the OSK rate is 1kHz). The start-oscillation and stop-oscillation of the internal crystal oscillator are controlled by the internal signal level or signal level from the **[FSK/Trig/Sync/Extmod]** connector on the rear panel. When the internal crystal oscillator starts to oscillate, the instrument starts to output the carrier waveform and when the internal crystal stops oscillating, the output stops.

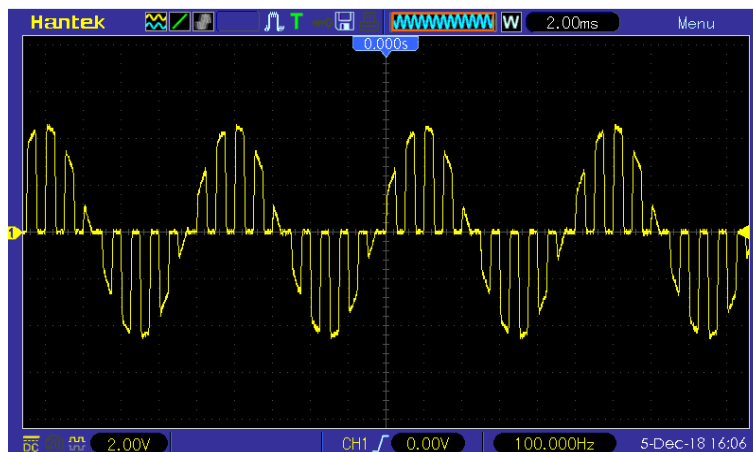

Figure 8.1 OSK Modulation

8.12.1 Select OSK Modulation

Press **[Mod]** > **Type** > **OSK** softkey to enable OSK function.

- When **Mod** is enabled, **Sweep** or **Burst** will be disabled automatically.
- After OSK is enabled, the instrument will generate OSK waveform with the currently specified carrier and modulating waveforms. To avoid multiple waveform changes, enable modulation after configuring the other modulation parameters.

8.12.2 Carrier Waveform Shape

OSK carrier waveform can only be sine waveform. Press **[Wave]** > **Sine** softkey on the front panel to select.

8.12.3 Carrier Waveform Frequency

For different carrier waveforms, the settable range of carrier frequency is different. Please refer to "Frequency Characteristics" in Specifications. The default value is 1kHz. Press **[Setting]** > **Frequency** softkey on the front panel, and then use the numeric keypad or direction keys and knob to input the desired frequency value.

8.12.4 Modulation Source

Press **[Mod]** > **Source** softkey to select Internal (default) or External as the modulation source.

internal Source

When internal modulation source is selected, the modulating waveform is set as a Square with 50% duty cycle, and the intermittence time and oscillate time of the output

signal is determined by the OSK "Rate".

external Source

When external modulation source is selected, the signal generator receives the external modulation signal from the **[FSK/Trig/Sync/Extmod]** connector on the rear panel.

8.12.5 OSK Rate

When internal modulation source is selected, press **[Mod] > Rate** softkey to set.

- Use the numeric keypad or direction keys and knob to input the desired rate value.
- The rate range is from 2mHz to 1MHz and the default is 100Hz.

Note: This menu will be grayed out and disabled when the external modulation source is selected.

8.12.6 Oscillate Time

Oscillate time is the oscillation period of internal crystal oscillator. The settable range of the oscillate time is related to the OSK rate currently selected. Press **[Mod] > OscTime** softkey and use the numeric keypad or direction keys and knob to input the desired time. The default range is from 8ns to 4.99975ms.

8.13 PWM Modulation

A modulated waveform consists of a carrier waveform and a modulating waveform. In PWM, the pulse width of the carrier waveform varies with the voltage level of the modulating waveform.

8.13.1 Select PWM Modulation

PWM is only available for the Square waveform.

Press **[Wave] > Square** softkey, and then press **[Mod] > Type > PWM** softkey to enable the PWM function.

- If the Square function has not been selected as carrier waveform, PWM in **[Mod] > Type** menu is unavailable.
- When **Mod** is enabled, **Sweep** or **Burst** will be automatically disabled (if enabled currently).
- After PWM is enabled, the instrument will generate PWM waveform with the currently specified carrier and modulating waveforms.

8.13.2 Carrier Waveform Shape

PWM is only available for the Square waveform. Press **[Wave]** > **Square**.

8.13.3 Carrier Waveform Duty

Press **[Wave]** > **Square** softkey to select square as carrier waveform. Press **[Setting]** > **Duty** softkey, then input the required value through the numeric keypad or knob.

8.13.4 Modulation Source

Press **[Mod]** > **SignalSrc** softkey to select Internal, External or Another Channel as the modulation source.

internal Source

When internal modulation source is selected, press **Shape** softkey to select Sine, Square, Ramp, Noise or Arb as the modulation source. The default is Sine.

- Sine
- Square: 50% duty cycle
- Ramp: 50% symmetry.
- Noise
- Arb: Sinc, Exp Fall, Haver Sine, Lorentz, Gause, Dual Tone, ECG.

Note: Noise can be used as modulating waveform but cannot be used as carrier waveform.

external Source

When external modulation source is selected, the Frequency and Shape menu in the modulation menu is grayed out and disabled. The instrument receives the external modulation signal from the **[FSK/Trig/Sync/Extmod]** connector on the rear panel. The Duty Deviation is controlled by $\pm 4V$ signal level on this connector.

another ch

CH1 and CH2 can be used as modulation sources reciprocally. When CH1 is used as the modulated wave, CH2 can be used as the modulation source. And vice versa. When selecting another channel as the modulation source, please turn on the output of that channel.

8.13.5 Modulation Frequency

When internal modulation source is selected, press **[Mod]** > **Frequency** softkey to set the frequency of the modulating waveform.

- Use the numeric keypad or direction keys and knob to enter the desired frequency value.
- The modulating waveform frequency range is 2mHz to 1MHz, and the default value is 100Hz.

Note: This menu will be grayed out and disabled when other modulation sources except the internal modulation source is selected.

8.13.6 Duty Deviation

Press **[Mod]** > **Deviation** softkey and input the desired value using the numeric keypad or direction keys and knob.

Duty deviation represents the variation (in %) of the modulated waveform Duty relative to the original pulse Duty.

- Duty deviation range: 0.1% to 49.9%.
- The Duty deviation cannot exceed the current pulse Duty.
- Duty deviation is limited by the minimum Duty and current edge time setting.

When external modulation source is select, the Duty deviation is controlled by the $\pm 4V$ signal level on the **[FSK/Trig/Sync/Extmod]** connector on the rear panel

9 Sweep

In sweep mode, the instrument outputs the waveform that changes from the start frequency to the stop frequency at a specified sweep rate. HDG3000B supports linear sweep mode.

Users can configure the instrument to output one sweep from start frequency to stop frequency by applying an external or manual trigger. The instrument can sweep sine, square, pulse, ramp, Harmonic or arbitrary waveforms (except DC).

9.1 Select Sweep

Press **[Sweep]** button on the front panel to enable the Sweep function (the backlight of the key goes on), and **Mod** or **Burst** function will be automatically disabled (if currently enabled).

To avoid multiple waveform changes, enable the sweep mode after configuring the other parameters (as waveforms and amplitudes of basic waves).

Press **[Sweep]** button again to close sweep mode.

9.2 Start Frequency and Stop Frequency

The generator sweeps from the start frequency to the stop frequency and then returns back to the start frequency.

- Start Frequency < Stop Frequency: the generator sweeps from low frequency to high frequency.
- Start Frequency > Stop Frequency: the generator sweeps from high frequency to low frequency.
- Start Frequency = Stop Frequency: the generator outputs with a fixed frequency.

When **[Sweep]** is enabled, press **Start Freq/Center Freq** softkey to highlight the "Start Freq". The "Stop Freq" in the **Stop Freq/Freq Span** softkey is also highlighted. Use the numeric keyboard or direction keys and knob to input the desired frequencies. By default, the start frequency is 100Hz and the stop frequency is 1KHz. Different sweep waveform corresponds to different start frequency and stop frequency range. For frequency parameters of different waveforms, please refer to "Frequency Characteristics" in Specifications.

After modifying the frequency, the generator will restart to output the frequency sweep signal with the specified frequency.

9.3 Center Frequency and Frequency Span

Users can also set the sweep frequency boundaries of the sweep using a center frequency and frequency span.

- Center Frequency = (Start Frequency + Stop Frequency) / 2

- Frequency Span = Stop Frequency – Start Frequency

When [Sweep] is enabled, press **Start Freq/Center Freq** softkey to highlight "Center Freq". The "Freq Span" in the **Stop Freq/Freq Span** softkey is also highlighted. Use the numeric keyboard or direction keys and knob to enter the desired frequency values. By default, the center frequency is 550Hz and the frequency span is 900Hz. Different sweep waveform corresponds to different center frequency and frequency span range and center frequency and frequency span are inter-related.

Define the minimum frequency of the waveform currently selected as F_{min} , the maximum frequency as F_{max} and $F_m = (F_{min} + F_{max})/2$.

The range of center frequency is from F_{min} to F_{max} . For frequency parameters of different waveforms, please refer to "Frequency Characteristics" in Specifications.

The range of the frequency span is influenced by the center frequency:

Center frequency $< F_m$: frequency span range is $\pm 2 \times (\text{center frequency} - F_{min})$;

Center frequency $\geq F_m$: frequency span range is $\pm 2 \times (F_{max} - \text{center frequency})$.

Take sine as an example. F_{min} is 1 μ Hz, F_{max} is 160MHz and F_m is about 80MHz.

If the center frequency is 550Hz, the range of the frequency span is:

$$\pm 2 \times (550\text{Hz} - 1\mu\text{Hz}) = \pm 1.099999998\text{kHz};$$

if the center frequency is 155MHz, the range of the frequency span range is:

$$\pm 2 \times (160\text{MHz} - 155\text{MHz}) = \pm 10\text{MHz}.$$

After modifying the frequency, the generator will restart to output the frequency sweep signal with the specified frequency.

Note: In large-scale sweep, the amplitude characteristic of the output signal might change.

9.4 Linear Sweep

HDG3000B provides linear sweep type.

The output frequency of the instrument varies linearly in the way of "several Hertz per second". The variation is controlled by "Start Freq", "Stop Freq" and "Sweep Time".

9.5 Sweep Time

Sweep time specifies the time required to sweep from the start frequency to the stop frequency.

When [**Sweep**] is enabled, press **Sweep Time** softkey and use the numeric keyboard or knob to change the sweep time.

The default value is 1s and the settable range is from 1ms to 50Ks.

9.6 Return Time

Return time specifies the number of seconds to return from the stop frequency to the start frequency.

When **[Sweep]** is enabled, press the **Ret Time** softkey and use the numeric keyboard or knob to change the return time.

The default value is 1s and the settable range is from 1ms to 50Ks.

9.7 Hold Time

The hold time specifies how long time the waveform stays at the stop frequency.

When **[Sweep]** is enabled, press the **Hold Time** softkey and use the numeric keyboard or knob to change the hold time.

The default value is 1s and the settable range is from 1ms to 50Ks.

9.8 Mark Frequency

When the output signal frequency is less than the specified mark frequency, there will output the low level signal from the **[FSK/Trig/Sync/Extmod]** connector on the rear panel. When the output signal frequency is at or greater than the specified mark frequency, the signal outputs on the **[FSK/Trig/Sync/Extmod]** connector will change from low level to high level.

When **[Sweep]** is enabled, press **Tag Frequency** softkey and use the numeric keyboard or the direction keys and knob to modify the mark frequency. The default value is 500Hz and the settable range is limited by the "Start Frequency" and "Stop Frequency".

9.9 Sweep Trigger Source

The sweep trigger source could be internal, external or manual. The generator will generate a sweep output when a trigger signal is received and then wait for the next trigger signal.

When **[Sweep]** is enabled, press **Trig Src** softkey to select **internal**, **external** or **manual**. The default is internal.

- **internal:** The generator outputs continuous sweep waveform at a rate determined by the total of the specified sweep time, return time and hold time.
- **external:** The signal generator receives the trigger signal from the **[FSK/Trig/Sync/Extmod]** connector on the rear panel. A sweep will be generated once the connector gets a TTL pulse with specified polarity. To set the TTL pulse polarity, press **Polarity** to select "Positive" or "Negative". The default is "Positive".
- **manual:** A sweep will be generated from the corresponding channel once you press **[Trigger]** at the front panel.

9.10 Trigger Output Edge

In sweep mode, when "Internal" or "Manual" trigger source is selected, the generator will output a TTL compatible signal with specified edge from the **[FSK/Trig/Sync/Extmod]** connector on the rear panel.

Internal and Manual Trigger:

The generator outputs a Pulse waveform from the **[FSK/Trig/Sync/Extmod]** connector on the rear panel at the beginning of the Sweep. The trigger period depends on the specified frequency sweep time, return time, and hold time. When the output signal frequency is less than the specified mark frequency, there will output the low level signal from the **[FSK/Trig/Sync/Extmod]** connector on the rear panel. When the output signal frequency is at or greater than the specified mark frequency, the signal outputs on the **[FSK/Trig/Sync/Extmod]** connector will change from low level to high level.

External Trigger:

The **[FSK/Trig/Sync/Extmod]** connector is used as the input terminal of external trigger signal and has no trigger output

10 Burst

The HDG3000B can output a waveform for a specified number of cycles, called a burst. It supports control of burst output by internal, external or manual trigger source; supports three kinds of burst types including N cycle, Infinite cycle and Gated. Burst is allowed with sine, square, ramp, pulse, Harmonic, noise (allowed only in gated burst mode) or arbitrary waveforms (except DC).

10.1 Select Burst

Press [**Burst**] button on the front panel to enable Burst function (the backlight of the key goes on), and **Mod** or **Sweep** function will be automatically disabled (if currently enabled).

To avoid multiple waveform changes, enable burst mode after configuring other parameters.

10.2 Burst Type

This instrument could output three types of bursts, including N Cycle, Infinite Cycle and Gate. The default is N Cycle.

Burst Type	Trigger Source	Carrier Waveform
N Cycle	Internal/External/Manual	Sine/Square/Ramp/Pulse/Harmonic/Arbitrary waveform (except DC)
Infinite	External/Manual	Sine/Square/Ramp/Pulse/Harmonic/Arbitrary waveform (except DC)
Gated	Ext	Sine/Square/Ramp/Pulse/Noise/Harmonic/Arbitrary waveform (except DC)

Table 10.1 Table Burst type

N Cycle Burst

In N Cycle mode, the generator will output waveform with specified number of cycles after receiving trigger signal.

Press [**Burst**] > **Type** softkey to select “**N Cycle**”.

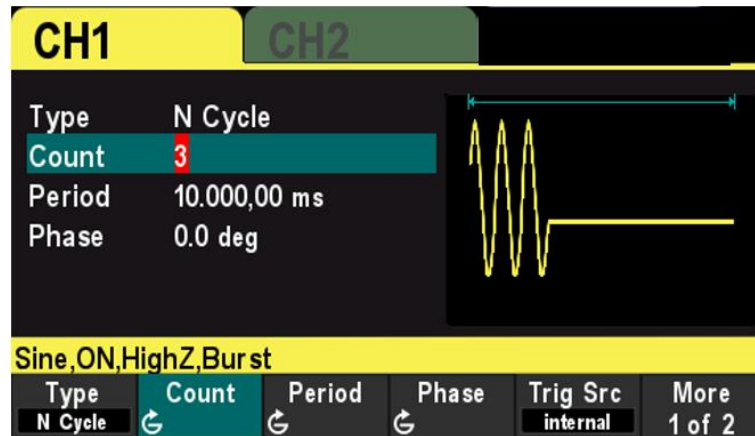

Figure 10.1 N Cycle Burst

For N Cycle mode, the trigger source includes "Internal", "External" or "Manual". Besides, users can set the "Phase", "Count", "Burst Period" (internal trigger), "Trigger Slope" (external trigger) and "Trigger" (manual trigger).

Infinite Cycle Burst

In Infinite Cycle mode, the cycle number of the waveform is set as an infinite value. The generator outputs a continuous waveform after receiving trigger signal.

Press **[Burst] > Type** softkey to select "Inf Cycle". A schematic diagram of infinite cycle pulse will be displayed on the screen.

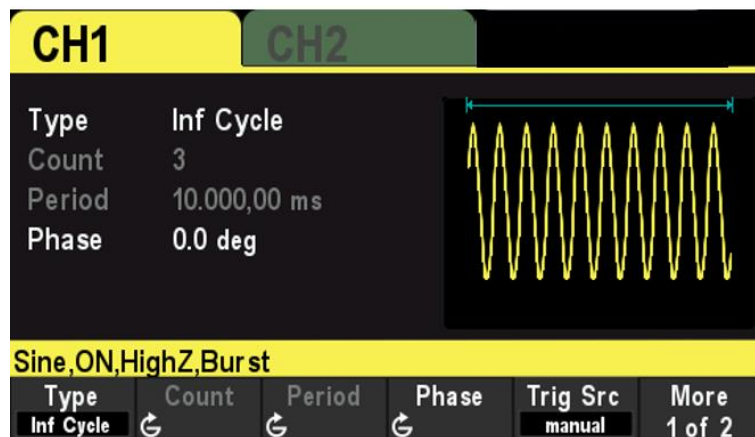

Figure 10.2 Infinite Cycle Burst

For Infinite Cycle mode, the trigger source includes "Internal", "External" or "Manual". Besides, users can set the "Phase", "Count" and "Trigger Slope" (external trigger) and "Trigger" (manual trigger).

Gated Burst

In Gated Mode, the generator controls the waveform output according to the external signal level from the **[FSK/Trig/Sync/Extmod]** connector on the rear panel.

Press **[Burst] > Type** softkey to select "Gate" and then press **Polarity** to set the gated

polarity as "Positive" (or "Negative"). The generator outputs burst waveform only when the gated signal is "Positive" (or "Negative").

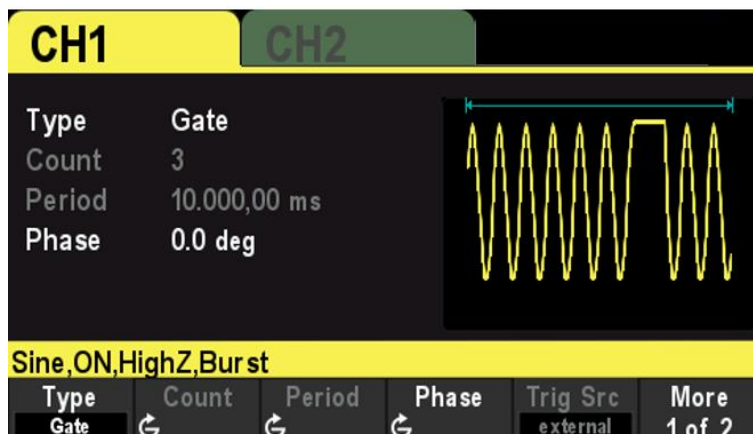

Figure 10.3 Gate Burst

When the gated signal is "True", the generator outputs a continuous waveform; when the gated signal is "False", the generator completes the current period, and then stops and holds on the voltage level corresponding to the initial burst phase of the selected waveform. For Noise waveform, the output will stop immediately once the gated signal becomes "False".

Gated Burst could only be triggered by External trigger source. In addition, users can set the "Phase".

10.3 Burst Count

Burst count is the number of carrier waveforms in one burst period. It is only available for N Cycle Burst mode (internal, external, or manually trigger sources).

For internal trigger source, Burst period $\geq 1\mu\text{s} + \text{Carrier Waveform Period} \times \text{Burst Count}$. Press **[Burst] > Type** softkey to select "N Cycle". The "Count" parameter is highlighted and is editable. And use the numeric keypad or direction keys and the knob to input the desired count. The default is 1 and the settable range is 1 to 2000 000 000.

This menu will be grayed out and disabled when the burst type is set to Infinite cycle or Gated.

10.4 Burst Period

Burst period is the time from the start of one burst to the start of next burst. It is only available for N Cycle burst in internal trigger. The default is 10 ms.

- Burst period $\geq 1\mu\text{s} + \text{Carrier Waveform Period} \times \text{Burst Count}$.
- If the burst period is set to too small, the generator will increase this period automatically to allow the output of the specified number of cycles.

Press **[Burst] > Type** softkey to select **N Cycle**. Press **Trig Src** softkey and select Internal, then press **Period** softkey, and use the numeric keypad or direction keys and

the knob to input the desired period. The default value is 10ms and the settable range is 2 μ s to 500s.

This menu will be grayed out and disabled when the burst type is set to Infinite cycle or Gated.

10.5 **Burst Phase**

Burst phase is defined as the phase of the start point of the burst.

When Burst is enabled, press **Phase** softkey and use the numeric keypad or direction keys and the knob to input the desired phase. The default value is 0° and the settable range is 0° to 360°.

- For Sine, Square, Ramp and Pulse, 0° is the point where the waveform passes through 0V (or DC offset value) positively.
- For arbitrary waveform, 0° is the first point of the waveform.
- For Noise, Start Phase is unavailable.

10.6 **Trigger Source**

Burst trigger source could be internal, external or manual. The generator will generate a burst output when a trigger signal is received and then wait for the next trigger

When Burst is enabled, press **Trig Src** softkey to select "**internal**", "**external**" or "**manual**". The default setting is "Internal".

Internal Trigger

When internal trigger is selected, the generator can only output N cycle burst and the burst frequency is determined by the "Burst Period".

External Trigger

When external trigger is selected, the generator can output N cycle, infinite or gated burst. The generator receives the trigger signal from the **[FSK/Trig/Sync/Extmod]** connector on the rear panel. A burst will be generated once the connector receives a TTL pulse with specified slope or polarity.

To set the external trigger slope, press **Slope** softkey to select "Rising" or "Falling" and the default is "Rising".

Manual trigger

When manual trigger is selected, the generator can output N cycle or infinite burst. A burst will be generated from the corresponding channel (if currently turned on) Once the Trigger button at the front panel is pressed. If the corresponding channel is not turned on, the trigger will be ignored.

10.7 Gate Polarity

Gate polarity is only available in gated burst mode. The generator will output burst when the gated signal from the **[FSK/Trig/Sync/Extmod]** connector on the rear panel is "High Level" or "Low Level".

When Burst is enabled, press **Type** softkey to select "**Gate**" and press **Polarity** softkey to select "Positive" or "Negative". The default is "Positive".

10.8 Trigger Output Edge

In burst mode, when the trigger source is "Internal" or "Manual", the generator would output a TTL-compatible signal with specified edge from the **[FSK/Trig/Sync/Extmod]** connector on the rear panel.

- **Internal trigger:** The generator outputs a square waveform with variable duty cycle (related to the carrier period and number of cycles) from the **[FSK/Trig/Sync/Extmod]** connector at the start of the burst.
- **Manual trigger:** The generator outputs a pulse from the **[FSK/Trig/Sync/Extmod]** connector at the start of the burst.
- **External Trigger:** The **[FSK/Trig/Sync/Extmod]** connector is used as the input terminal of external trigger signal and has no trigger output.

11 Counter

The generator provides a counter which can measure various parameters (such as frequency, period, duty cycle, positive pulse width and negative pulse width) of external input signal.

Press **[Utility] > Counter** softkey on the front panel to enable counter function. Input the signal to the Counter connector on the rear panel measure.

Press **Exit** softkey or any other key to exit the counter.

Press **Gate Time** softkey and use the direction keys and the knob to modify the current value.

The default value is 1s and the settable range is 10ms to 16s.

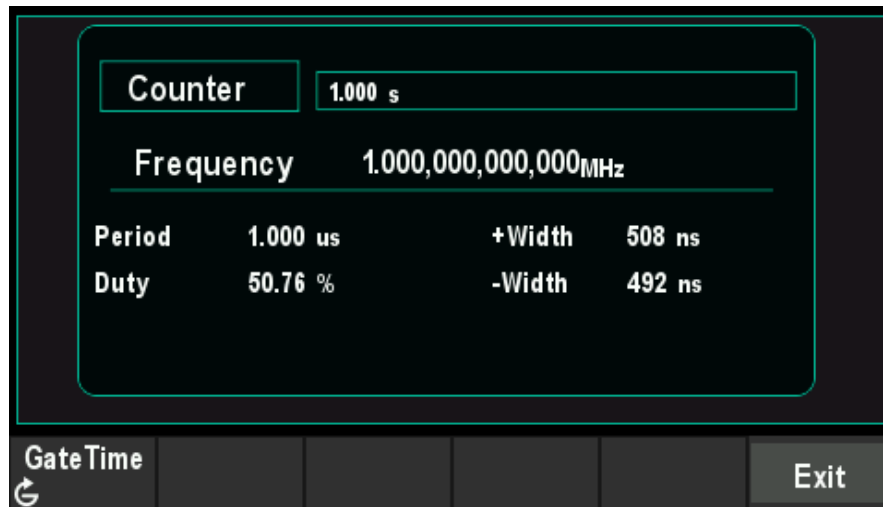

Figure 11.1 Counter

12 Store

The instrument allows the user to store the current settings state of the instrument in internal or external storage and recall it when needed.

12.1 Store System

The instrument provides an internal memory (home disk) and an external memory (USB disk).

Home disk: Users can save the instrument settings state to this disk in .pho format. And the file also can be recalled.

USB disk: Available when the instrument detects external storage (front USB port).

Users can save the instrument settings state to external storage in .pho format. The state files .pho and arbitrary waveform files .hwf in the external memory can be recalled.

The instrument settings state file includes waveform basic parameters,

Mod/Sweep/Burst parameters and counter parameters.

Press **[Utility] > Store** softkey to open the store interface, as shown in the figure below.

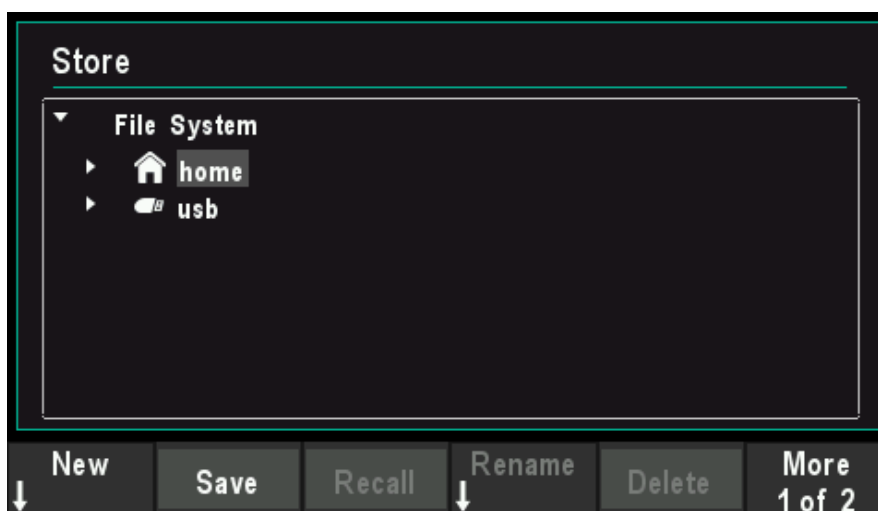

Figure 12.1 Store Interface

Note: The instrument can only identify filenames consist of English letters, number and underscore. If other characters are used to name the file or folder, the name might be displayed in the store and recall interface abnormally.

12.2 File Operation

Press **[Utility] > Store** softkey to enter File System, users can perform a series of operations on files or directories including New, Save, Recall, Rename, Delete, and

Refresh.

New File

In Store interface, rotate the knob to select home disk or usb disk, and then press **New** softkey to enter the filename editing interface, as shown in the figure below.

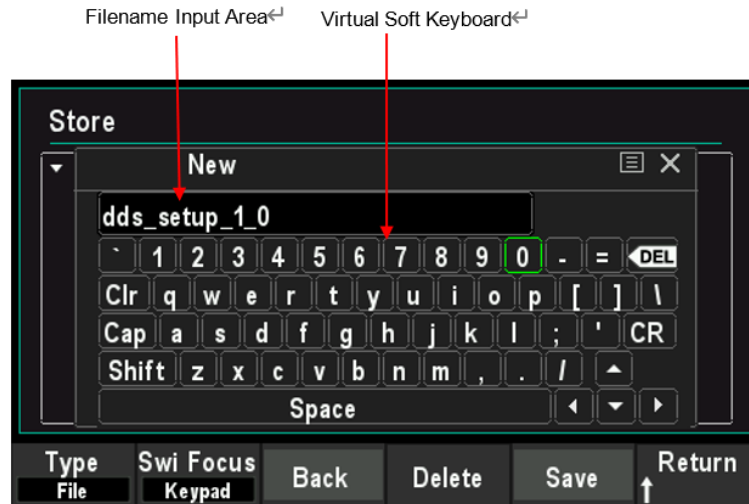

Figure 12.2 New File Interface

1. Press **Type** softkey to select "File".
File: Create a new state file.
Directory: Create a new directory.
2. Press **Swi Focus** softkey and select Name or Keypad.
Name: Put the cursor in the Filename Input Area. Use direction keys to move the cursor position and specify the location of the modified character.
Keypad: Put the cursor in the Virtual Keyboard. Rotate the knob to move the cursor position and press down the knob to input the character. In the virtual keyboard, rotate the knob to select Caps and press down to switch between uppercase and lowercase; rotate the knob to select Shift and press down to switch some symbols.
3. Press **Back** softkey to remove the characters in front of the cursor one by one.
4. Press **Delete** softkey to delete all the characters in the Filename Input Area.
5. After entering the file name in the Filename Input Area, press Save softkey to save the state file.
6. Press **Return** softkey to exit the New menu and return to the previous menu.

Save

Press **Save** softkey to automatically create a new state file and save it.

Recall

Press **Recall** softkey to recall the state file or arbitrary waveform file.

Rename

Use the knob to select the specified file or directory and press **Rename** softkey to rename. Refer to the operation method of creating a new file. After the completion of the denomination, press **Confirm** softkey to confirm the change.



Figure 12.3 Rename Interface

Delete

Use the knob to select the specified file or directory and press **Delete** softkey to delete the selected file or directory.

Refresh

Press **Refresh** softkey to refresh the file list.

13 Utility

The signal generator allows the user to configure channel parameters, configure remote interfaces, and set system parameters.

13.1 Sync

The synchronous signal is output from the **[FSK/Trig/Sync/Extmod]** connector on the rear panel. The instrument could output the sync signals of basic waveforms (except Noise), arbitrary waveforms (except DC), Harmonics, Sweep, Burst and Modulation from a single channel or two channels at the same time.

- The sync signal is a square waveform that is "high" in the first half of the cycle and "low" in the second half. When sync signal is disabled, the output level at the **[FSK/Trig/Sync/Extmod]** connector is logic low.
- The amplitude of Sync signal is not adjustable and is fixed at TTL level.

Sync Signals of Various Waveforms

- For Sine, Square, Ramp, and Pulse, the sync signal is a Square with 50% duty cycle. When the first wave point is output, the synchronization signal is TTL high level. When the frequency of the basic waveform is less than or equal to 30 MHz, the sync signal has the same frequency as the basic waveform. When the frequency of the basic waveform is greater than 30 MHz, the frequency of the sync signal is (the basic waveform frequency $\div 2^n$). Wherein, n represents the frequency dividing coefficient, and it is 1 when the frequency of the basic waveform is greater than 30 MHz and less than or equal to 60 MHz, and it is 2 when the frequency of the basic waveform is greater than 60 MHz and less than or equal to 90 MHz.
- For noise, there is no sync signal output.
- For arbitrary waveform, the sync signal is a square with 50% duty cycle. When the first wave point is output, the sync is TTL high level. The frequency of the sync signal is the frequency of arbitrary waveform.
- For harmonics, the sync signal is a square with 50% duty cycle. When the first waveform point is output, the sync signal is TTL high level. The frequency of the sync signal is the frequency of the basic wave.
- For AM, DSB-AM, FM, PM and PWM modulation, when internal modulation source is selected, the sync signal is a square with 50% duty cycle and takes modulating frequency as reference. When the first waveform point is output, the sync signal is TTL high level. When external modulation source is selected, there is no sync signal output.
- For ASK, FSK, PSK, BPSK, QPSK, 3FSK, 4FSK, OSK modulation, the sync signal is a square with 50% duty cycle and takes the modulating rate as reference. For ASK, FSK, PSK, OSK modulation, when external modulation is selected, there is no sync signal output.
- For Sweep, when the frequency of the sweep signal is less than the mark

frequency, the sync signal is a TTL low level. When the frequency of the sweep signal is at or greater than the mark frequency, the sync signal is changed from TTL low level to TTL high level.

- For N-cycle burst, when internal or manual are selected as the trigger source, the sync signal is TTL high level at the start of the burst. At the end of the specified count of cycles, the sync signal is TTL low level (it may not be zero intersection if the waveform has an associated starting phase). For an infinite-cycle burst, when manual triggered is selected, the sync signal is the same as that of the basic waveform. For all burst types, when external trigger is selected, there is no sync signal output.

13.2 Impedance Settings

The Impedance setting affects the output amplitude and DC offset voltage. For the front panel [1] connector, the HDG3000B has a fixed series output impedance of 50Ω . If the actual load is different from the specified value, then the displayed voltage level will not match the voltage level of the components under test. To ensure the correct voltage level, ensure that the load impedance setting must match the actual load.

Press [Utility] > CH1 Set > Imped softkey to choose HighZ or 50Ω . The default setting is HighZ. Impedance settings will be displayed on the screen. As shown in the figure below, the impedance of CH1 is set to "HighZ".

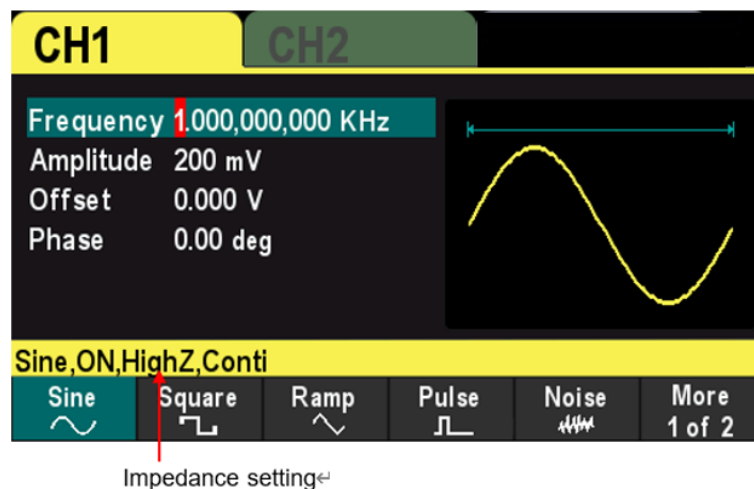

Figure 13.1 Impedance

The generator will adjust the output amplitude and offset voltage automatically once the impedance setting is changed. For example, the current amplitude is 5Vpp and the output impedance is 50Ω . At this point, change the output impedance to HighZ and the amplitude displayed on the screen will double to 10Vpp. And the current amplitude is 5Vpp and the output impedance is HighZ. At this point, change the impedance to 50Ω , the amplitude will reduce to half of the previous value (2.5Vpp).

Note: Only the displayed values change with the parameter and the real output

from the generator does not change.

13.3 System Settings

13.3.1 Language

The signal generator supports Chinese and English menu, and provides corresponding help information, prompt information and interface display.

Press [**Utility**] > **Language** softkey to select the desired language. When "Chinese" or "English" is selected, the menu, help message, prompt message, and interface are displayed in Chinese or English, respectively.

The language is not changed when the [P] key is pressed to restore the default settings.

13.3.2 Clock Source

The instrument provides an internal 10MHz clock source and can receive the external clock source from the [**10MHz In/Out**] connector at the real panel. It can also output the internal clock source from the [**10MHz In/Out**] connector for other devices.

Press **Utility** > **Clock Src** softkey to select "Internal" or "External". The default is "Internal". If "External" is selected, the instrument will detect whether a valid external clock signal is input from the [**10MHz In/Out**] connector at the real panel. If no valid clock source is detected, the prompt message "No valid 10MHz External Clock is detected" would be displayed and the clock source would be switched to "Internal".

Users can also synchronize two or more instruments by setting the clock source. When two instruments are synchronized, the SYNC of phase cannot be used. The SYNC of phase can only be used to adjust the phase relation between two output channels of the same instrument and cannot be used to change the phase relation between the output channels of two instruments. Users can change the phase relation between two instruments by change the "Start Phase" of each channel.

Sync methods for two or more instruments:

- Synchronization between two instruments:
Connect the **10MHz In/Out** connector of Generator A (set the clock source to "Internal") to the **10MHz In/Out** connector of Generator B (set the clock source to "External") and set the output frequencies of the two instruments as a same value to realize the synchronization between the two instruments.
- Synchronization among multi-instruments:
Divide the 10MHz clock source of a generator (set the clock source to "Internal") into multiple paths; then, connect them to the **10MHz In/Out** connectors of the

other generators (set the clock source to "External") respectively. Finally, set the output frequencies of all the generators as a same value to realize the synchronization among multi-instruments.

13.3.3 Power On Settings

Set the configuration to be used when the instrument is powered on the next time to **Default**, **Last** or **Output OFF**. The default setting is "Default".

- **Default:** Denote the factory default settings except some parameters (such as: Language).
- **Last:** Include all the system parameters and output configuration, except clock source.
- **Output OFF:** The last setting will be used and all output will be closed.

Press **[Utility] > Startup** softkey to select the desired configuration type.

When **[P]** key is pressed to restore the default settings, this setting will not be affected.

13.3.4 Intensity

Press **[Utility] > Intensity** softkey and use the direction keys and the knob to change the backlight intensity of the screen.

The ranges from 1% to 100%.

13.3.5 System Information

Press **[Utility] > System Info** softkey to view the information of the device (such as model, serial number, version number, etc.).

13.3.6 Unit

Press **[Utility] > Units** softkey to select units of waveform parameters.

- Frequency/Period - Select the period or frequency as the waveform parameter that can be set.
- Amplitude/high level - Select the amplitude or high level as the waveform parameter that can be set.
- Offset/Low Level - Select the offset or low level as the waveform parameter that can be set.
- Pulse width/duty cycle - Select the pulse width or duty cycle as the pulse parameters that can be set.

13.3.7 **Save Picture**

Users can store the content displayed on the screen in an external storage device in the form of pictures.

First, please connect the USB stick (FAT32 format, storage space is less than or equal to 32G) and insert the USB stick into the USB port on the front panel of the instrument. After successful connection, the corresponding prompt message pops up on the screen.

Then enter the interface that you need to save, and press **[Utility]** button, the instrument completes the screenshot and enters the Utility menu. At this time, the signal generator has cached the screenshot inside the instrument. Press **SavePic** softkey, and the instrument will save the screenshot to the USB stick.

Note: The screenshot cached is always the screen at the last time the [Utility] button was pressed.

13.4 **Firmware Update**

Copy the firmware to a USB stick (FAT32 format, storage space is less than or equal to 32GB) and insert the USB stick into the USB port on the front panel of the instrument. Press **[Utility] > Update** softkey, enter the file browser interface, use the knob to select the firmware file, press **Recall** softkey to specify the file, and then press **OK** softkey to start the firmware update.

14 Remote Control

The HDG3000B can be controlled remotely through the following two methods.

Use PC software

Users can use the PC software to send commands to remotely control the instrument. You can download the software from our official website.

User-defined programming

Users can program and control the instrument by using the SCPI (Standard Commands for Programmable Instruments) commands. For more information about the commands and programming, refer to the SCPI protocol manual.

HDG3000B can communicate with PC through USB. This chapter will give a detailed introduction of how to use software to control HDG3000B remotely through the real USB port.

- Install Keysight IO libraries suite
- Remote Control via USB

14.1 Install Keysight IO libraries suite

Users can download the application software package on the official website of Hantek:

<http://hantek.com/products/detail/17187>

Or click the following website to download latest one:

<http://www.keysight.com/main/software.aspx?ckey=2175637&id=2175637&nid=-11143.0.00&lc=eng&cc=GB>

Double click the icon to start installing.

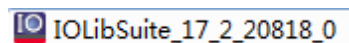

Click 'Next' to continue.



Read License Agreement and accept. Click 'Next' to continue.



Select a Typical and click 'Next' to continue.



Or select a Custom and click 'Next' to continue.



Select "Install Keysight VISA as primary VISA" and click 'Next' to continue.

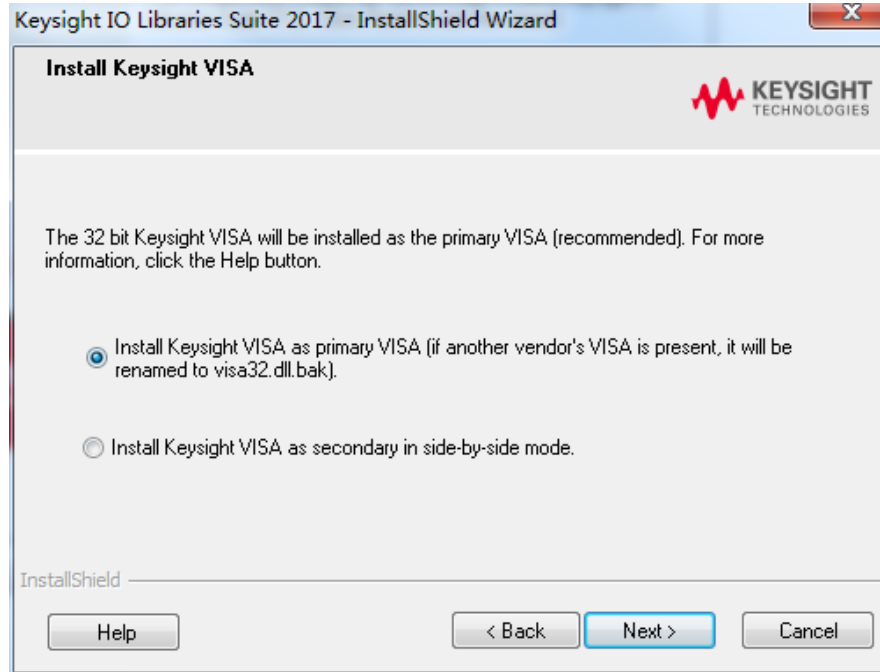

Click 'Install' to start copying files.

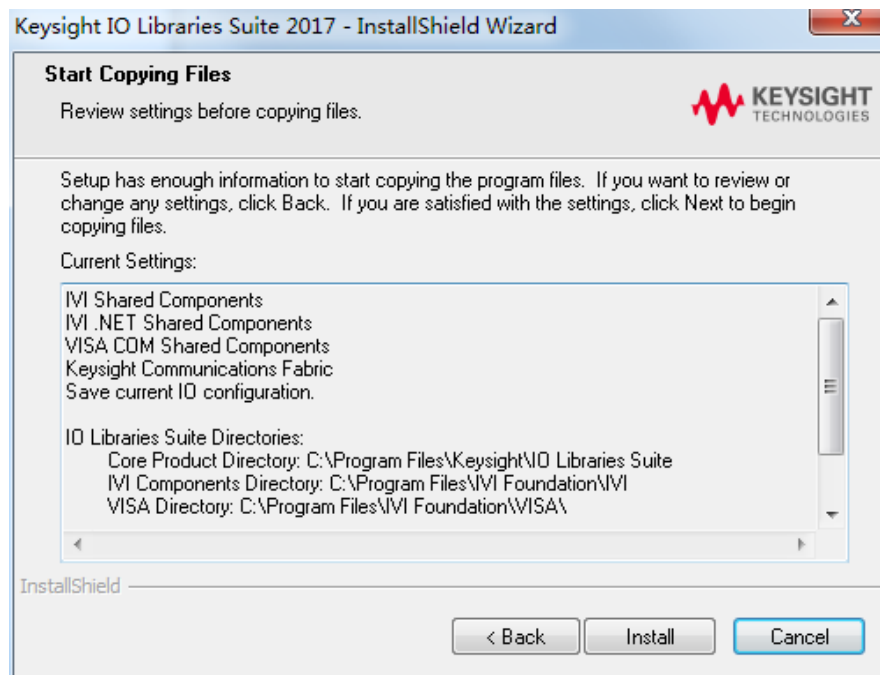

The installation is completed automatically. You will see the running IO program in the lower right corner of the screen.

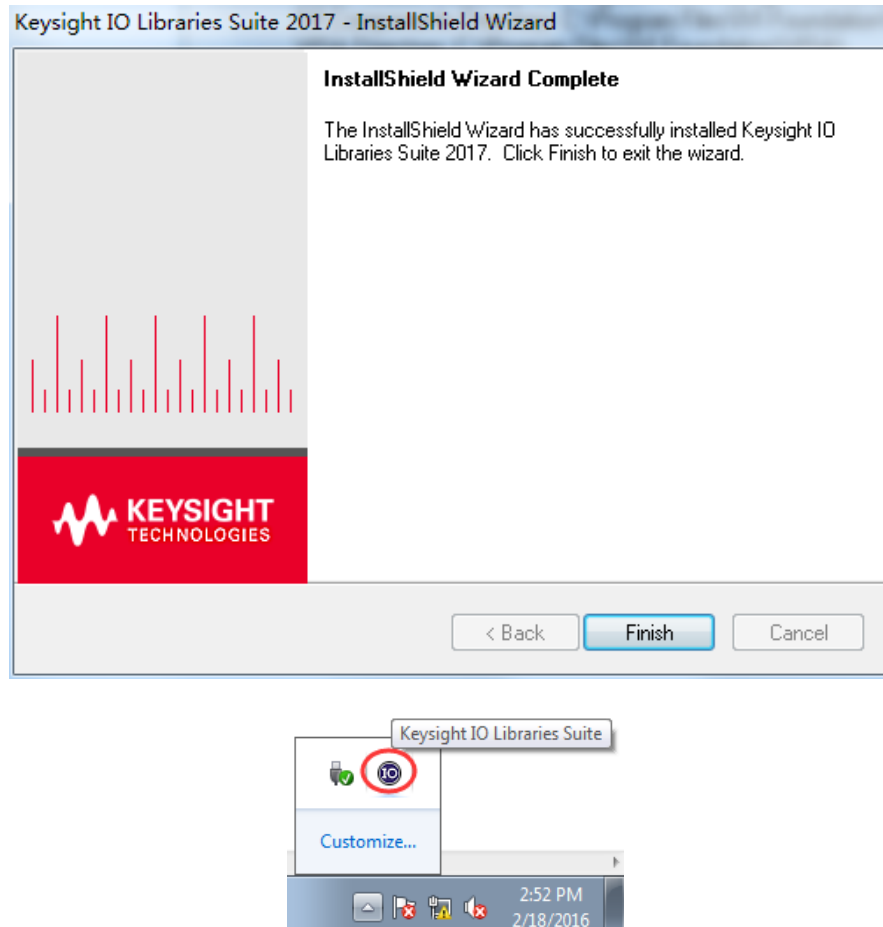

14.2 Remote Control via USB

Connect the device

Connect the instrument with your PC using a USB cable.

Search for device resource

Start up Keysight IO and the software will automatically search for the instrument resource currently connected to the PC. You can also click **Rescan** to search for the resources.

View the device resource

The resource found will appear under the directory, and the model number and USB interface information of the instrument will also be displayed.

For example, HDG3102C(USB0::0x0483::0x5740::*****::0::INSTR)

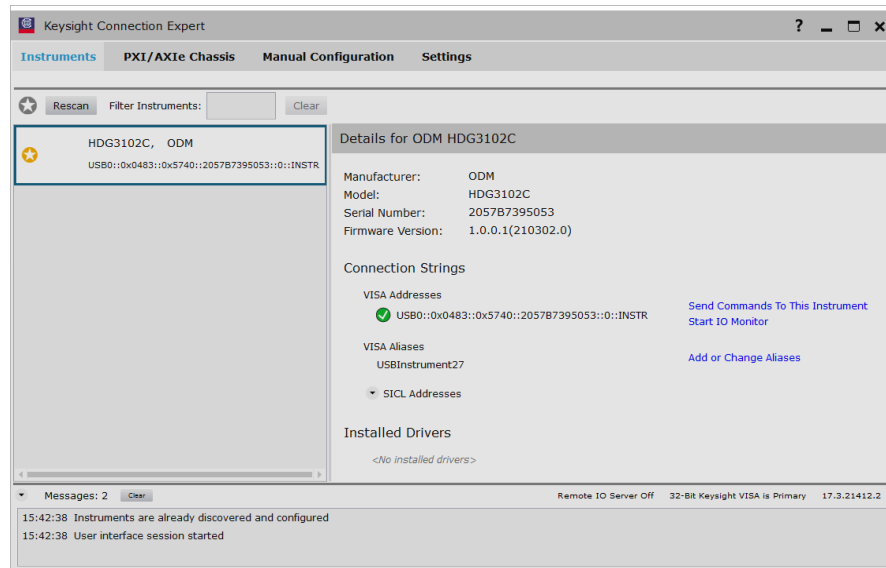

Control the instrument remotely

1. Use PC software

Users can download the application software package on the official website of Hantek: <http://hantek.com/products/detail/17187>

Double-click the Setup.exe file and install it according to the installation wizard.

After the installation is complete, the software icon will be displayed on the computer desktop.



Double click the software icon on the desktop after you finished the software setting and equipment connecting. Then a user interface will be shown as follows:

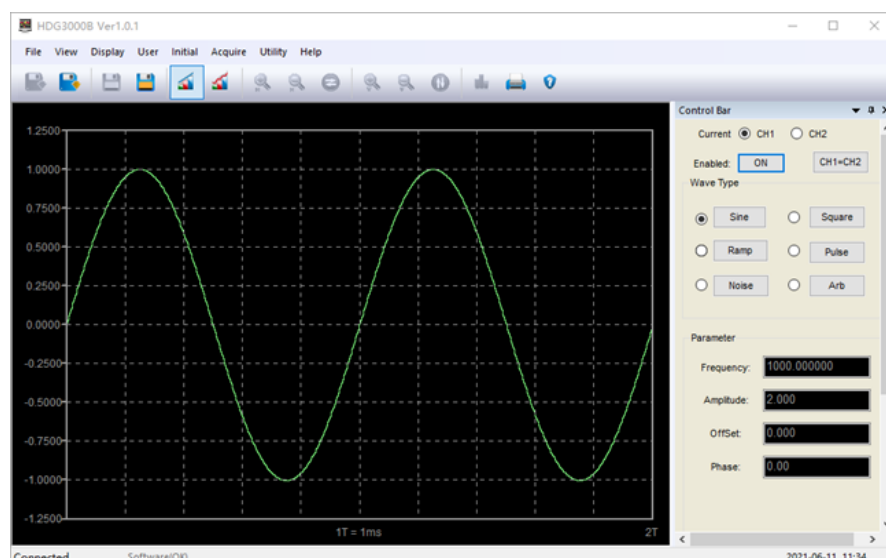

2. User-defined programming

Start up Keysight IO and the software will automatically search for the instrument resource currently connected to the PC.

Click “Send Commands To This Instrument” to open Keysight interactive IO interface.

You can send commands and read data.

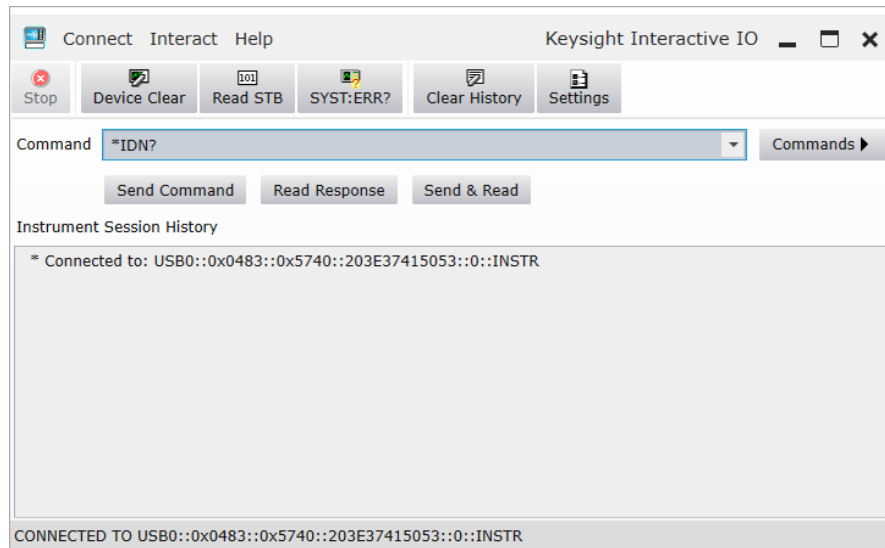

For more information about the commands and programming, refer to the SCPI protocol manual.

15 Troubleshoot

The following lists the possible faults and troubleshooting methods during the use of HDG3000B. When you encounter these faults, please follow the corresponding steps to deal with them. If you cannot solve them, please contact the local distributor or directly contact Hantek, and please provide the system information of the machine. (Get method: [Utility] -> [System Info](#)).

1. When press the power button, the instrument displays a black screen:

- 1) Check whether the power cord connector is connected properly.
- 2) Check whether the power button is pressed firmly.
- 3) After completing the above checks, restart the instrument.
- 4) If the product still cannot be used normally, please contact Hantek.

2. The screen display is too dark to see clearly:

- 1) Check whether the backlight intensity of the LCD screen is too small.
- 2) Press [Utility] -> Intensity, use the numeric keyboard to adjust the backlight intensity of the LCD screen of the instrument to a suitable state. You can also use the arrow keys and knob to adjust the backlight intensity.

3. The instrument settings are correct but no waveform output:

- 1) Check that the BNC cable is securely connected to the output connector of [CH1] or [CH2] channel.
- 2) Check whether the BNC cable is damaged internally.
- 3) Check whether the BNC cable is tightly connected to the test instrument.
- 4) Check whether the backlight of the Output1 or Output2 button is lit. If it is not lit, press the corresponding button to turn on.
- 5) If the product still cannot be used normally after completing the above checks, please contact Hantek.

4. The USB stick device cannot be recognized:

- 1) Check whether the USB stick device can work normally when connected to other instruments or computers.
- 2) Confirm that the USB stick is a FAT32 formatted device.
- 3) After restarting the instrument, insert the USB stick device to check again.
- 4) If the USB stick still cannot be used normally, please contact Hantek.

5. How to set the amplitude of the waveform in dBm?

- 1) Select the desired channel.
- 2) Check whether the output impedance in the channel setting interface is 50Ω ([Utility] -> CH1 Set).
- 3) Select the desired waveform, press the **Amplitude** softkey, input the desired value through the numeric keyboard and select the unit **dBm**.

16 Appendix

16.1 Appendix A: Accessories

Order information	Order number
Host model	
15MHz, 2-channel	HDG3012B
25MHz, 2-channel	HDG3022B
40MHz, 2-channel	HDG3042B
60MHz, 2-channel	HDG3062B
80MHz, 2-channel	HDG3082B
100MHz, 2-channel	HDG3102B
Standard accessories	
Power cord that conforms to the standard of the host country	— —
BNC to BNC	HT322
Crocodile clip (2)	HT324
USB cable	— —

16.2 Appendix B: Warranty summary

Qingdao Hantek Electronics Co., LTD. (hereinafter referred to as Hantek) undertakes that the host and accessories of its production shall be free from any material and process defects during the warranty period.

During the warranty period, if the product is proved to be defective, Hantek will repair or replace the product free of charge. Please refer to the description on Hantek official website for detailed warranty regulations. For repair service or full warranty instructions, please contact Hantek repair center or local offices.

Hantek disclaims warranties, express or implied, other than those provided in this

summary or any other applicable warranty card, including, but not limited to, any implied warranties of merchantability and fitness for special purpose. In no event shall Hantek be liable for indirect, special or consequential damages.



Addr: #35 Building, No. 780 Baoyuan Road, High-tech Zone, Qingdao, Shandong, China 266114

Switchboard: 400-036-7077

Email: service@hantek.com

Tel: (0086)532-55678770 & 55678772 & 55678773

Zip code: 266114

Website: www.hantek.com

Qingdao Hantek Electronics Co., LTD