

Hantek 1008
DIGITAL OSCILLOSCOPE

USER's MANUAL

V1.0.5

Content

| | |
|--|-----------|
| General Safety Summary | 1 |
| Chapter 1 Getting Start | 2 |
| 1.1 System Requirement..... | 3 |
| 1.2 Install and Run Software | 3 |
| 1.4 General Features | 4 |
| 1.5 General Check | 4 |
| 1.6 Probe Compensation..... | 5 |
| 1.7 Self Calibration | 6 |
| 1.8 The User's Interface | 7 |
| 1.9 Input Connectors | 9 |
| Chapter3 Understanding Oscilloscope Functions | 10 |
| 3.1 Setup the Oscilloscope..... | 11 |
| 3.2 Set Vertical System | 12 |
| 3.3 Setup Horizontal System | 13 |
| 3.4 Set Trigger System..... | 14 |
| 3.5 Set MATH..... | 16 |
| 3.6 Set Reference | 18 |
| 3.7 Save and Load | 20 |
| 3.8 Record and Play Back..... | 20 |
| 3.8 Utility Menu..... | 21 |
| 3.9 Measure Signal | 22 |
| 3.9.1 Cursor Menu..... | 22 |
| 3.9.2 Measure Menu | 24 |
| 3.10 Display System..... | 27 |
| 3.11 Zoom In/Out..... | 29 |
| 3.12 Print and Print Preview | 30 |
| 3.13 Generate Square Waveform..... | 31 |
| Chapter 4 Application Example | 34 |
| 4.1 Simple Measurement | 35 |
| 4.2 Capturing a Single-Shot Signal | 36 |
| 4.3 The Application of the X-Y Operation | 36 |
| 4.4 Taking Cursor Measurements..... | 38 |
| Appendix | 41 |
| Appendix A: Specifications | 42 |
| Appendix B: General Maintenance..... | 44 |

General Safety Summary

Review the following safety precautions carefully before operate the device to avoid any personal injuries or damages to the device and any products connected to it. To avoid potential hazards use the device as specified by this user's guide only.

- **To Avoid Fire or Personal Injury.**
- **Connect and Disconnect Properly.** Do not connect or disconnect probes or test leads while they are connected to a voltage source.
- **Connect and Disconnect Properly.** Connect the probe output to the measurement device before connecting the probe to the circuit under test. Disconnect the probe input and the probe reference lead from the circuit under test before disconnecting the probe from the measurement device.
- **Observe All Terminal Ratings.** To avoid fire or shock hazard, observe all ratings and markings on the product. Consult the product manual for further ratings information before making connections to the product.
- **Use Proper Probe.** To avoid shock hazard, use a properly rated probe for your measurement.
- **Avoid Circuit or Wire Exposure.** Do not touch exposed connections and components when power is on.
- **Do Not Operate With Suspected Failures.** If suspected damage occurs with the device, have it inspected by qualified service personnel before further operations.
- **Provide Proper Ventilation.** Refer to the installation instructions for proper ventilation of the device.
- **Do not operate in Wet/Damp Conditions.**
- **Do not operate in an Explosive Atmosphere.**
- **Keep Product Surfaces Clean and Dry.**

Chapter 1 Getting Start

The oscilloscope is small, lightweight, no external power required, portable oscilloscope. The oscilloscope is ideal for production test, research and design and all of the applications involving analog circuits test and troubleshooting, as well as education and training.

In addition to the list of general features on the next page, this chapter describes how to do the following tasks:

- ◆ **System Requirements**
- ◆ **Install and Software**
- ◆ **General Features**
- ◆ **General Check**
- ◆ **Probe Compensation**
- ◆ **Self Calibration**
- ◆ **The User's Interface**
- ◆ **Input Connector**

1.1 System Requirement

Operating System

Win7 / Win8 / Win10

1.2 Install and Run Software

Download

Firstly, please scan the two-dimension code on scope or click the following link to download the software and user guide.



<https://e.hantek.com/Products/hantek1008c>

Install Software

Double click **Setup.exe**. According to the information, install the software step by step.

There will be "Hantek1008" icon on desktop.



Connect the device with PC

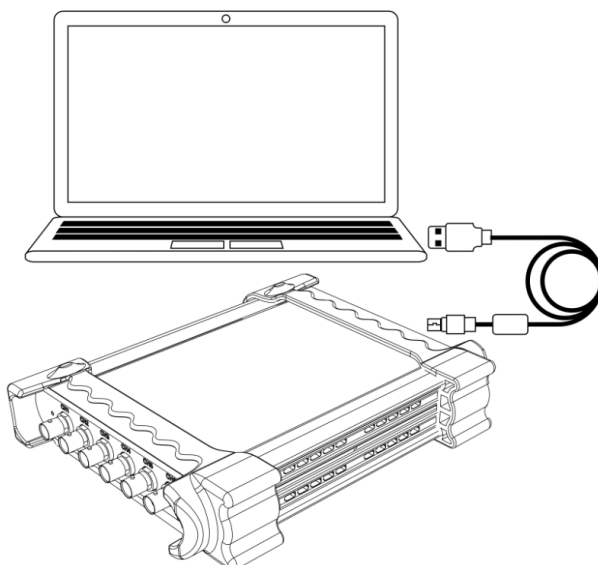

Run the software

Double click  icon on desktop to run the software.

1.4 General Features

Product features:

- ◆ 8 Channels
- ◆ Maximum real-time sample rate: 2.4MSa/s
- ◆ Memory depth: 4K points
- ◆ Built-in Fast Fourier Transform function(FFT);
- ◆ 20 Automatic measurements;
- ◆ Automatic cursor tracking measurements;
- ◆ waveform storage, record and replay dynamic waveforms;
- ◆ User selectable fast offset calibration;
- ◆ Add, Subtract , Multiply and Division Mathematic Functions;
- ◆ Adjustable waveform intensity, more effective waveform view;
- ◆ User interface in several user-selectable languages;

1.5 General Check

Please check the instrument as following steps after receiving an oscilloscope:

- ◆ **Check the shipping container for damage:**
Keep the damaged shipping container or cushioning material until the contents of the shipment have been checked for completeness and the instrument has been checked mechanically and electrically.
- ◆ **Check the accessories:**
Accessories supplied with the instrument are listed in "Accessories" in this guide. If the contents are incomplete or damaged, please notify the franchiser.
- ◆ **Check the instrument:**
In case there is any mechanical damage or defect, or the instrument does not operate properly or fails performance tests, please notify the franchiser.

1.6 Probe Compensation

Perform this function to match the characteristics of the probe and the channel input. This should be performed whenever attaching a probe to any input channel at the first time.

- ◆ From the “**Probe**” menu, select attenuation to **1:10**. Set the switch to “**X10**” on the probe and connect it to CH1 of the oscilloscope. When using the probe hook-tip, insert the tip onto the probe firmly to ensure a proper connection. Attach the probe tip to the **Probe Compensator** and the reference lead to the ground connector, select CH1. Adjust the vertical and horizontal controls to meet your measurement to optimize the waveform display.
- ◆ Check the shape of the displayed waveform.

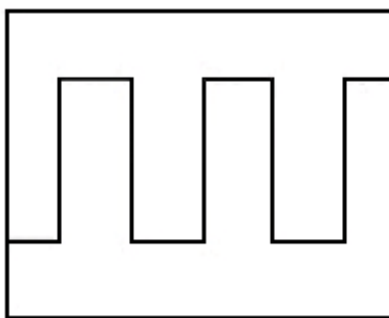

Correctly Compensated

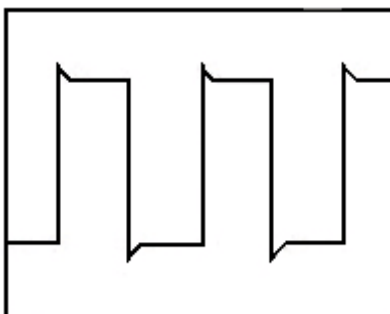

Over Compensation

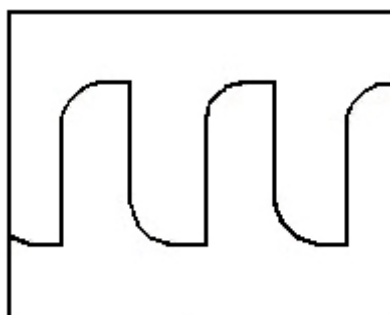

Under Compensation

- ◆ If necessary, use a non-metallic tool to adjust the trimmer capacitor of the probe for the flattest square wave being displayed on the oscilloscope.
- ◆ Repeat if it is necessary.

1.7 Self Calibration

The self calibration routine lets you optimize the oscilloscope signal path for maximum measurement accuracy. You can run the routine at any time but you should always run the routine if the ambient temperature changes by 5°C or more. For accurate calibration, power on the oscilloscope and wait twenty minutes to ensure it is warmed up. To compensate the signal path, disconnect any probes or cables from the input connectors. Then, access the “**More -> Utility -> Calibration**” option and follow the directions on the screen. The self calibration routine takes about several minutes.

1.8 The User's Interface

Click the software icon on the desk after you finished the software setting and equipment connecting. Then a user interface will be showed as follows:

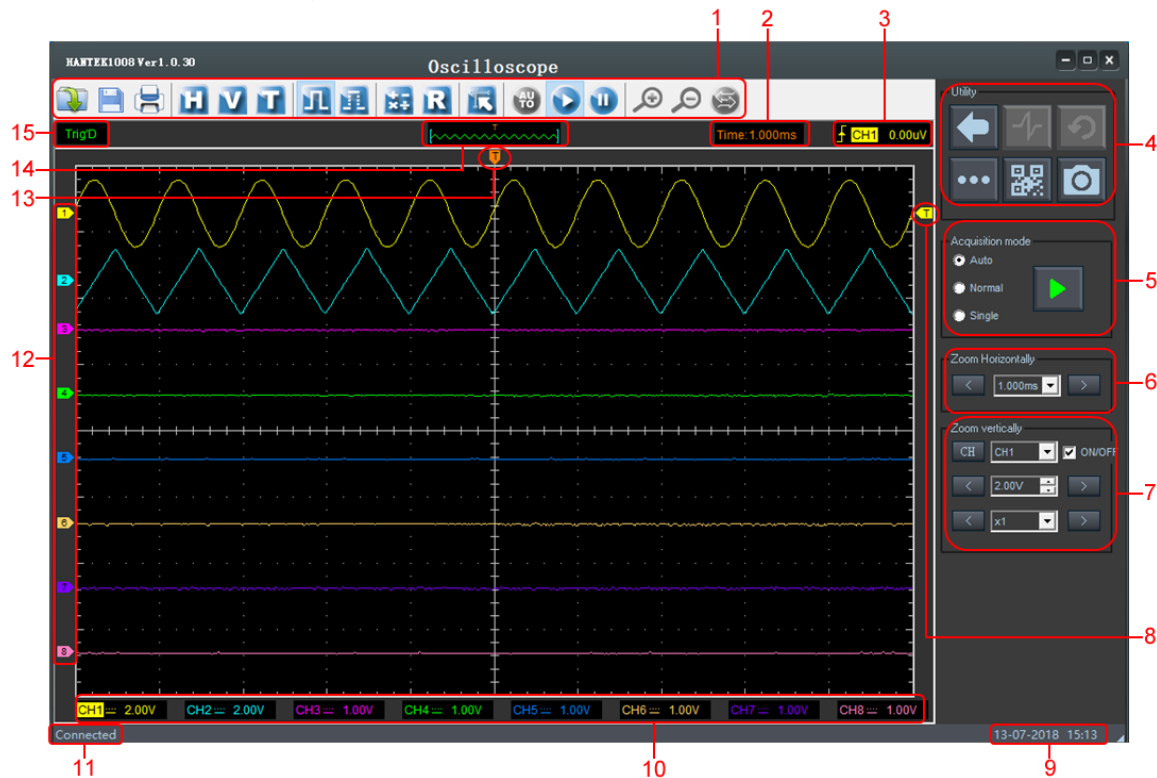

In addition to displaying waveforms, the display area is filled with many details about the waveform and the oscilloscope control settings.







1. Toolbar

2. Current Time Base(Time/Div)

3. Trigger Information

It shows the edge trigger slope, source and level.

4. Functional Panel

-  Return: Return to function select interface.
-  Turn on/off reference waveform of vehicle diagnosis.
-  Default: Default setting in vehicle diagnosis.
-  More: Functional menu.
-  QR code: Click or scan QR code to get measurement help.
-  Screenshot: Save as .bmp or .jpg files.

5. Acquisition mode**6. Horizontal Setting Panel**

The user can select horizontal Time/Div.

7. Vertical Setting

The user can turn on/off the CH1-CH8. Also the user can change the CH1-CH8 Volt/Div and probe attenuation.

8. Marker of trigger level.**9. It shows System Time.****10. It shows CH1-CH8 information**

Readouts show the vertical scale factors of the channels.

11. It shows Software status.

Connected: It means the device is connected with PC successfully.

Searching Device: It means the device isn't connect with PC. Or the software works in demo.

12. The markers show the CH1-CH8 reference points of the displayed waveforms. If there is no marker, the channel is not displayed.**13. Marker of horizontal trigger position.****14. A window that shows the display waveform in buffer position.****15. Marker of horizontal trigger position.****Trigger status indicates the following:**

Trig'D: The oscilloscope has seen a trigger and is acquiring the post trigger data.

WAIT: All pretrigger data has been acquired and the oscilloscope is ready to accept a trigger.

STOP: The oscilloscope has stopped acquiring waveform data.

RUN: The oscilloscope is running.

PLAY: The oscilloscope is displaying the record waveforms.

1.9 Input Connectors

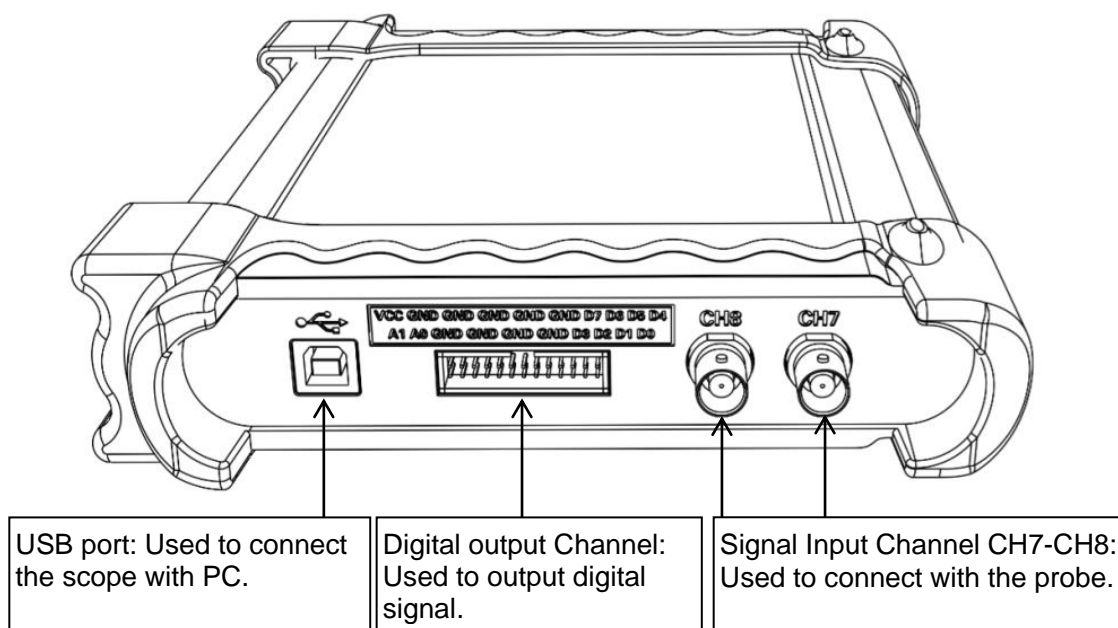
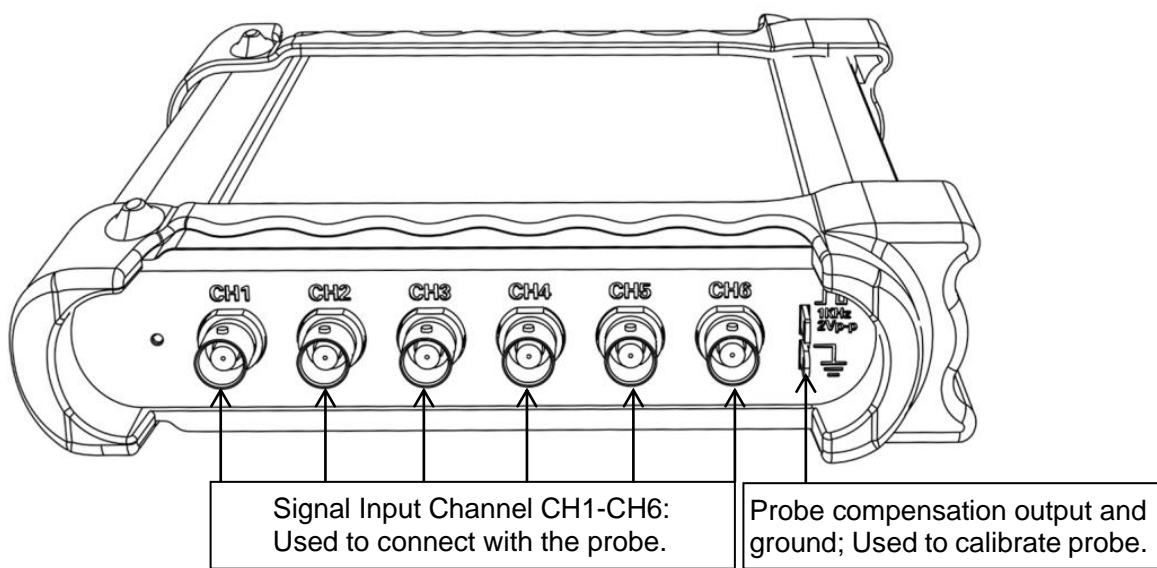

Chapter3 Understanding Oscilloscope

Functions

- ◆ Set Oscilloscope
- ◆ Set Vertical System
- ◆ Set Horizontal System
- ◆ Set Trigger System
- ◆ Save/Load
- ◆ Utility Function
- ◆ Measure Signal
- ◆ Display System
- ◆ Waveform Generator
- ◆ Zoom In/Out Waveforms
- ◆ Acquisition
- ◆ Print
- ◆ Generate Square Waveform

3.1 Setup the Oscilloscope

Save Setup

The oscilloscope software saves the current setup before you close the oscilloscope software. The oscilloscope recalls this setup the next time you run the software. You can use the “**Save Setup**” menu to permanently save up to several different setups.

Load Setup

The oscilloscope can recall the last setup before the oscilloscope software was running, any saved setups, or the factory setup. You can use the “**Load Setup**” menu to permanently recall a setup.

Factory Setup

The oscilloscope software is set up for normal operation when it is shipped from the factory. This is the factory setup. To recall this setup, push the “**Factory Setup**” menu.

3.2 Set Vertical System

Click “**More->Setup->Vertical**” Menu.

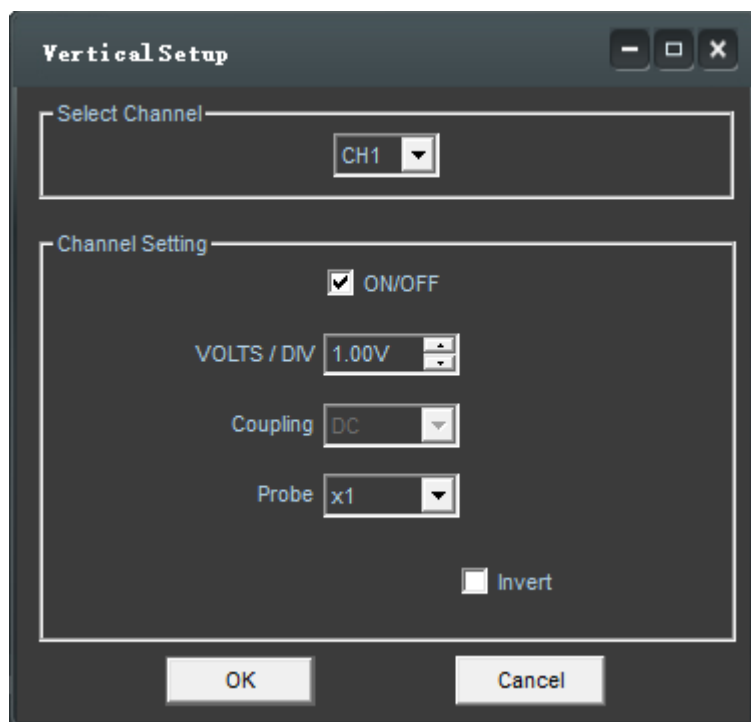

- **Select Channel:** CH1-CH8
- **Channel Setting:**
 - ON/OFF:** Turn on/off the channel
 - Volt/DIV:** Select the channel voltage/div
 - Coupling:** DC coupling
 - Probe:** Select the channel probe attenuation

Change Volt/DIV

You can click “**Volt/Div**” to select the voltage range.

Probe Attenuation Setting

Select the attenuation factor for the probe. To check the probe attenuation setting, toggle the probe menu to match the attenuation factor of the probe.

This setting remains in effect before you changed again.

Click “**Probe**” in Vertical Setup window to select the probe attenuation.

Note: The attenuation factor changes the vertical scale of the oscilloscope so that the measurement results reflect the actual voltage levels at the probe tip.

Also users can select channel and set Volt/Div and probe attenuation in sidebar.

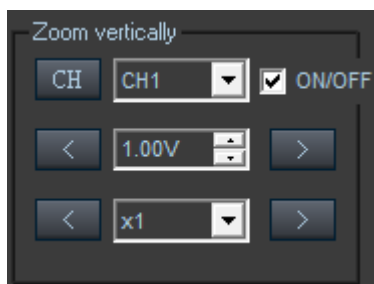

3.3 Setup Horizontal System

Click “**More->Setup->Horizontal**” Menu.

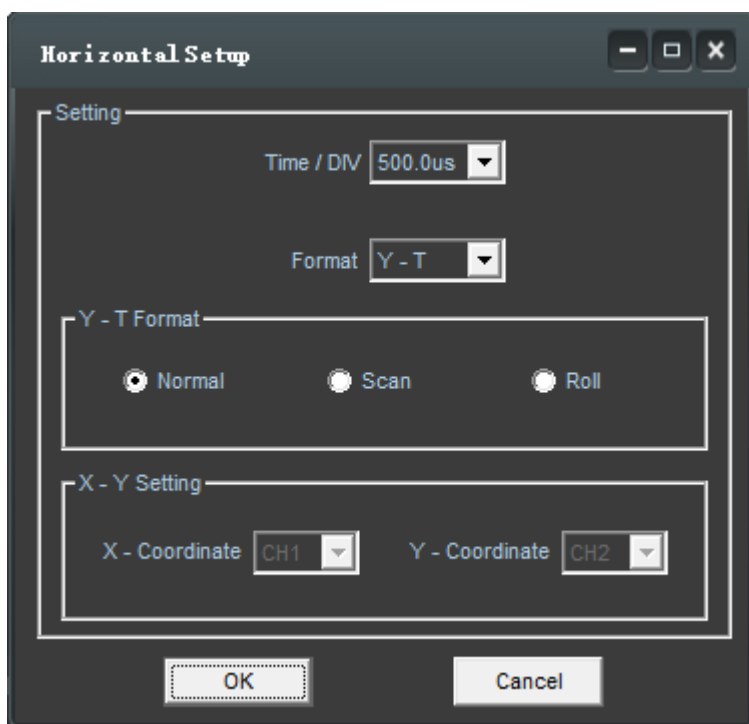

➤ **Change Time/DIV**

Select the horizontal **Time/DIV** (scale factor).

Also user can select left and right arrows or Combox to change **Time/Div** in sidebar.

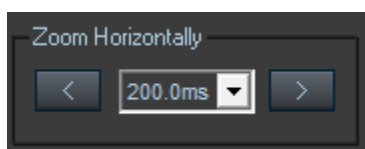

If the waveform acquisition is stopped, **Time/Div** control expands or compresses the waveform.

➤ **Format**

In the “**Format**” item, set the waveform display format (**Y-T**, **X-Y**).

Y-T: Show the relative relation between vertical voltage and horizontal time
X-Y: Show CH1 value at X axis; CH2 value at Y axis. The XY format is used to analyzer phase difference, such as those represented by Lissajous patterns. Please refer to [4.3 Section](#).

X-Y Setting: Users can change X-Coordinate and Y-Coordinate for two different channels.

➤ Y-T Format

Scan: In Scan Mode, the waveform display updates from left to right.

Roll: In Roll Mode, the waveform display updates from right to left.

In **Roll** mode, the waveform display rolls from right to left. No trigger or horizontal offset control of waveforms is available during Roll Mode, and it's only available when set to 500ms/div or slower.

➤ Change Horizontal Position

Horizontal position changes the displayed waveform position, relative to the trigger point.

The user can drag  on screen to change the horizontal position.

3.4 Set Trigger System

Click "**More->Setup->Trigger**" Menu.

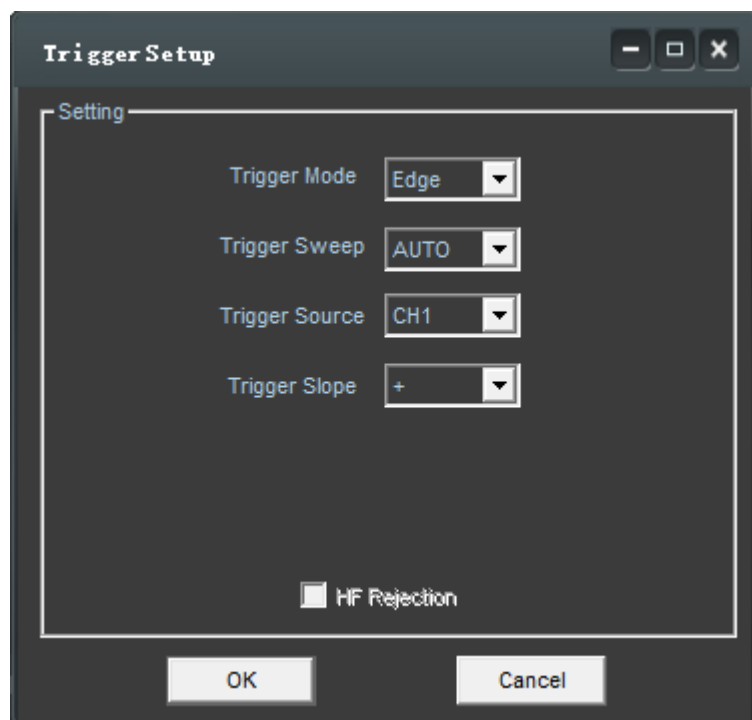

Edge Trigger

The trigger determines when the oscilloscope starts to acquire data and display a wave- form. When a trigger is set up properly, it can convert unstable displays or blank screens into meaningful waveforms. If the oscilloscope wants to acquire a waveform, it collects enough data so that it can draw the waveform to the left of the trigger point. The oscilloscope continues to acquire data while waiting for the trigger condition to occur. The oscilloscope continues to acquire enough data so that it can draw the waveform to the right of the trigger point after it detects a trigger.

The **Edge** trigger determines whether the oscilloscope finds the trigger point on the rising or the falling edge of a signal. Select **Edge** trigger mode to trigger on **Rising** edge or **Falling** edge.

Mode: Edge trigger.

Sweep: Set the sweep mode to **Auto**, **Normal** or **Single**.

Auto: Acquire waveform even no trigger occurred.

Normal: Acquire waveform when trigger occurred.

Single: Acquire waveform when trigger occurred then stop

Source: You can use the trigger source options to select the signal that the oscilloscope uses as a trigger. The source can be any signal connected to a channel BNC.

Slope: Set the slope to **Rising (+)** or **Falling (-)**.

Rising: Trigger on rising edge

Falling: Trigger on falling edge

3.5 Set MATH

Click “**More->Setup->Math**” Menu.

The **MATH Setup** window:

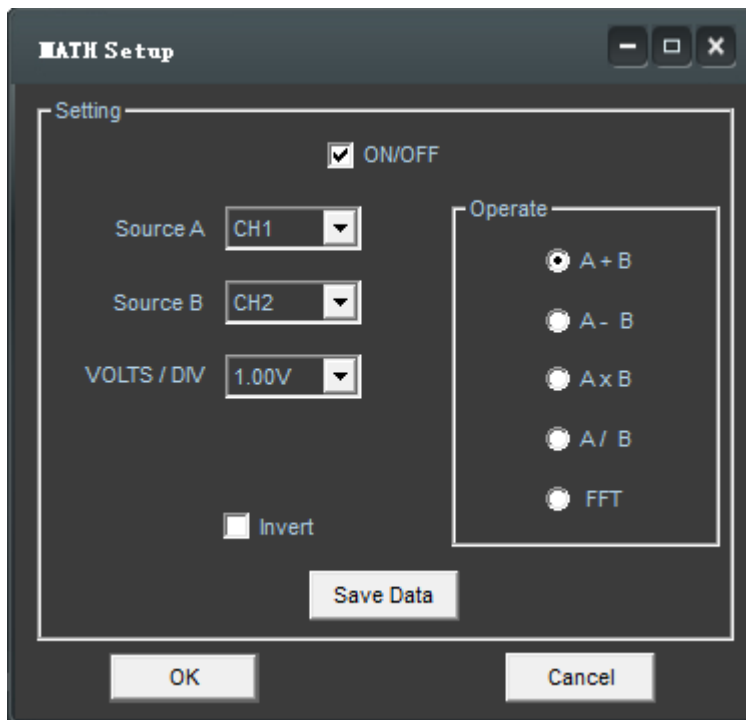

ON/OFF: Turn On/Off the MATH Channel.

Source A/B: Set the sources of the math channel.

Operate: Set operates type of the math channel.

Volt/DIV: Set the resolution of the math channel.

Invert: Turn on/off the invert function

The mathematic functions include addition, subtract, multiply and FFT.

Operate

Four Types:

- A + B Add source A and source B
- A – B Subtract source B from source A
- A x B Multiply source A by source B
- A / B Divide source A by source B
- FFT Convert a time-domain signal into its frequency components (spectrum).

In this function, use the addition, subtraction, multiplication and FFT function to operate and analyze the waveform.

Select the operate type in the **Operate** menu. Select source A and B. Then adjust the vertical scale and offset to view the math channel clearly. The mathematic result can be measured by the measure and the cursor.

The Math Function Display

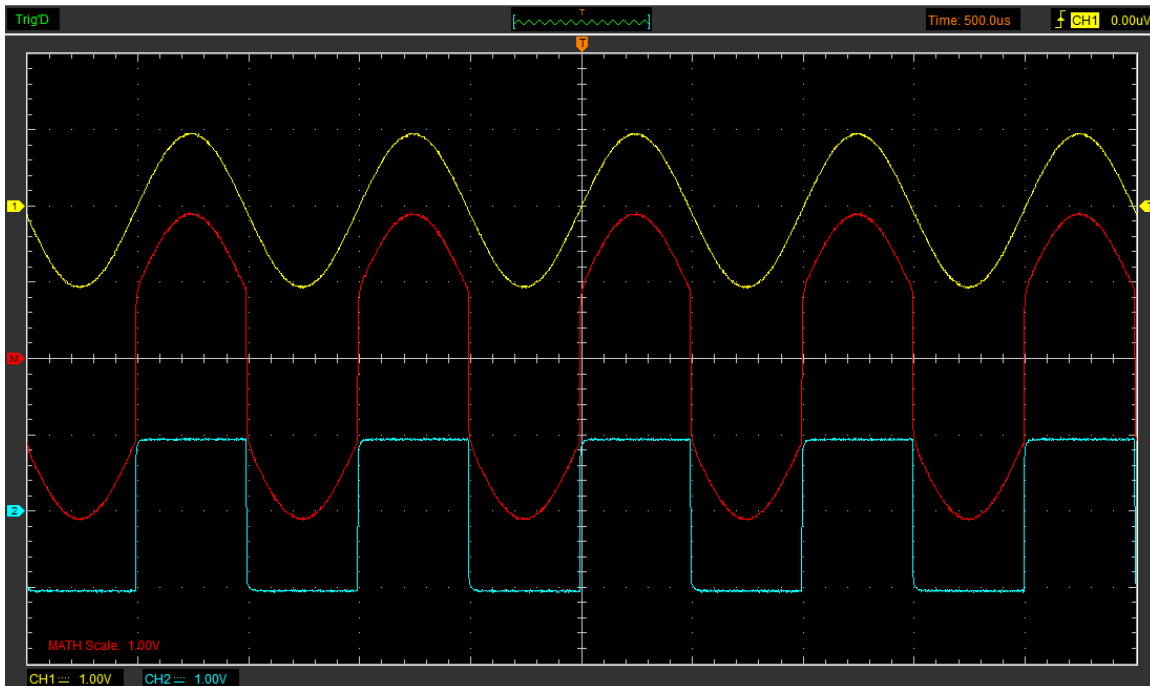

Fast Fourier Transform Function

To use the FFT mode, you need to click  in Toolbar to open the FFT setup window.

The FFT setup window:

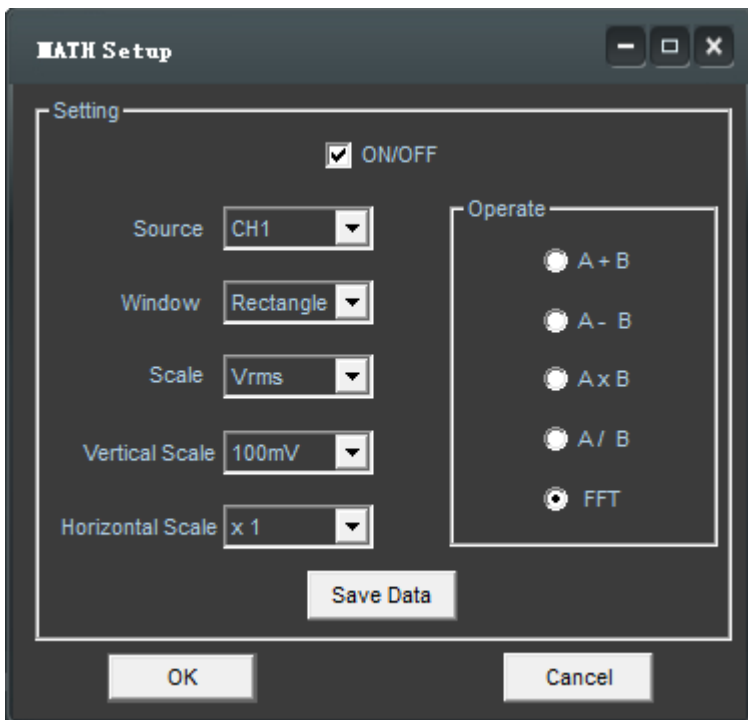

You can select the Source channel, Window algorithm, FFT number, and FFT Zoom factor. It displays only one FFT spectrum at a time.

Source: Selects the channel used as the FFT source

Window: Selects the FFT window type

Scale: Selects the vertical scale units

Vert Scale: Selects the vertical scale

HORI Scale: Selects the FFT zoom factor

Set horizontal scale, If the information is more than the quantity displayed to the display window, more information is displayed by using scroll bar.

3.6 Set Reference

Click "**More->Setup->REF**" Menu.

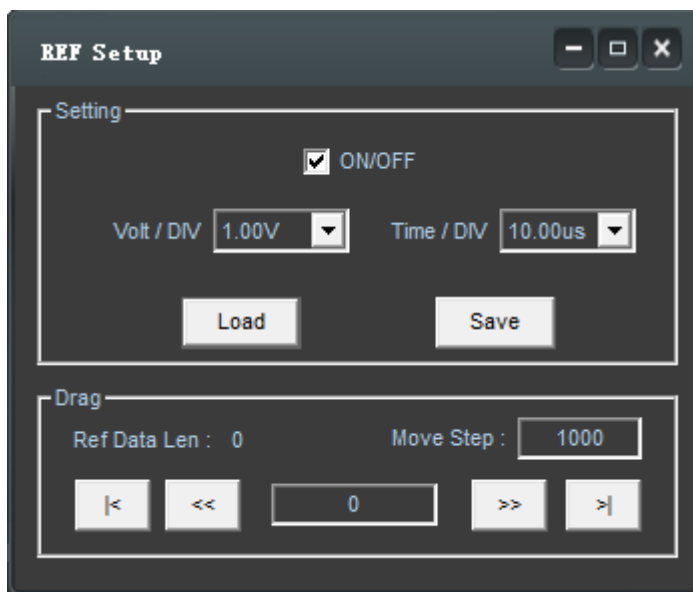

The Reference Channel Function:

On/OFF: Turn on/off the reference channel.

Volt/DIV: Channel the resolution of the reference channel.

Time/Div: Select the horizontal **Time/DIV** of the reference channel.

Load: Load the reference waveform from the ".rfc" file from your computer.

Save: Save the current reference waveform to your computer as ".rfc" format.

Save Reference: Save the current reference waveform to your computer as "rfc" format.

You can change the vertical scale of a waveform. The waveform display will contract or expand relative to the reference level.

Load

Click "**Load**" to load the "*.rfc" file that was selected. The load file window will appear.

Save

Click **Save** to save the waveform to *.rfc file. The saved source window appears.

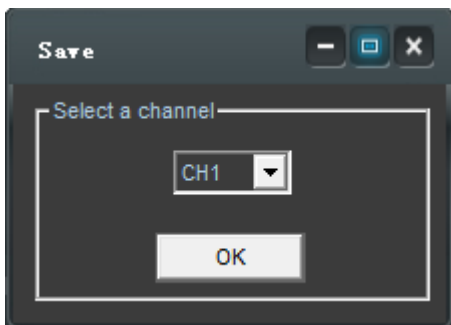

The save file window will appear after you selected the saved source.

The Reference Waveform Display Window:

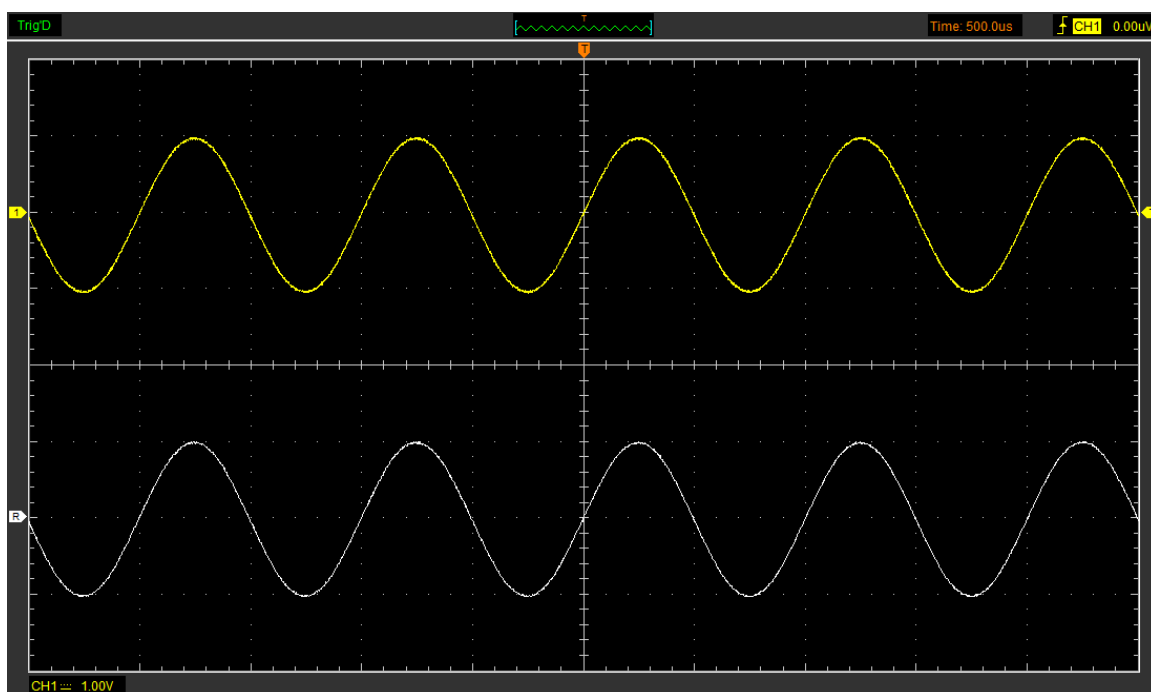

Note: If you turn on the “Reference” channel, the load file window will appear.

3.7 Save and Load

Click "**More->File**" menu to save waveform, setups and image.

1. Save Data

Save waveform data as a type file

2. Save Setup

Save the current oscilloscope setup to file

3. Save Image

Save the software display window as a .bmp or .jpg file

Load Menu

Click "**File**" in main menu to recall saved waveform, setup

1. Load Data

Load the waveform that had saved as a type file.

2. Load Setup

Load the instrument that had saved.

3.8 Record and Play Back

Click "**More->Setup->Record**" menu.

The **Record** window will display in sidebar. The following picture shows the **Record** Interface.

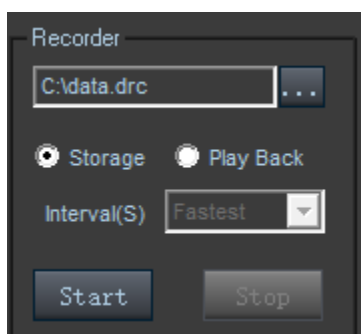

This function can record input waveform from CH1 to CH4.

“**Storage**” button: Record waveform and save it as “.dfr” file.

“**Start**” button: Start to record waveforms.

“**Stop**” button: Stop recording waveforms.

Click “**More->Setup->Record**” menu again to close the window.

“**Play Back**” button: Click this button to start playing back the saved waveform.

3.8 Utility Menu

➤ **Factory Setup**

Click “**More->Utility->Factory Setup**” menu to load default setups.

When you click the **Factory Setup** menu, the oscilloscope displays the CH1-CH8 waveforms and removes all other waveforms.

The oscilloscope set up for normal operation when it is shipped from the factory and can be recalled at anytime by user.

The Factory Setup function does not reset the following settings:

- ◆ Language option
- ◆ Date and time

➤ **Calibration**

Please refer to [Self Calibration](#).

➤ **Language**

Click “**More->Language**” menu

There are three languages in “**Language**” menu. The default language is English.

3.9 Measure Signal

3.9.1 Cursor Menu

Click "**More->Cursor**" menu.

This method allows you to take measurements by moving the cursors

1. Source

The user can set the source to **CH1-CH8** and **MATH**.

When you use cursors, be sure to set the **Source** to the waveform on the display that you want to measure.

2. Type

There are four types of cursors: **Cross**, **Trace**, **Vertical** and **Horizontal**

1) Cross

The **Cross** cursors appear as cross lines on the display and measure the vertical and horizontal parameters.

The **Cross** cursor display window:

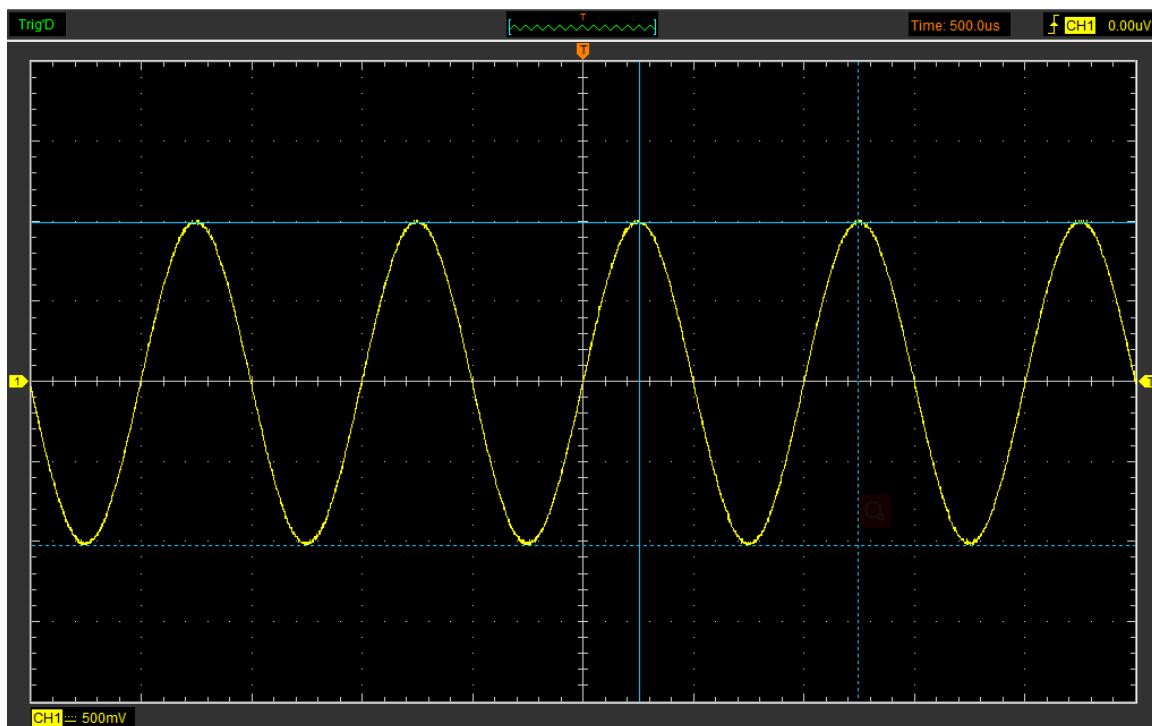

The **Cross** measure result displays on status bar

Freq: 1.004KHz Time: 996uS Volt: 1.99V

2) Trace

The **Trace** cursors appear as vertical lines on the display and measure the waveform amplitude at the point the waveform crosses the cursor.

The **Trace** cursor display window:

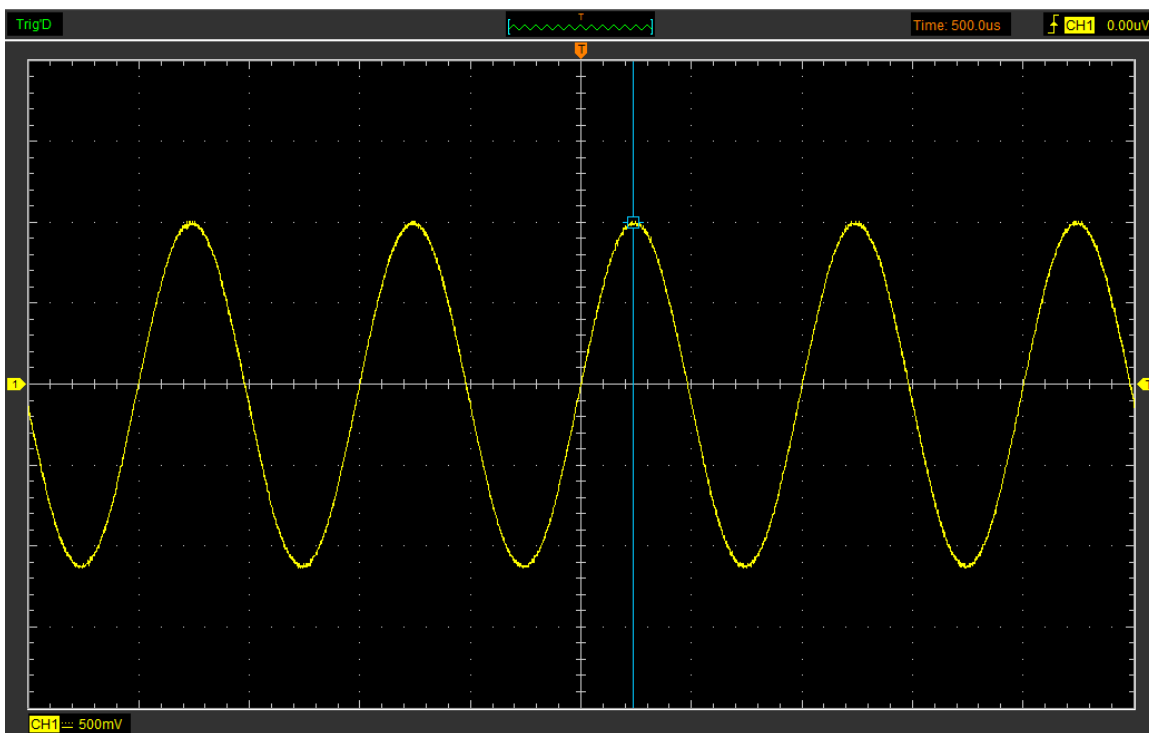

The **Trace** cursor measure result display on status bar

Volt: 997mV

3) Vertical

The **Vertical** cursors appear as vertical lines on the display and measure the vertical parameters.

The **Vertical** cursor display window:

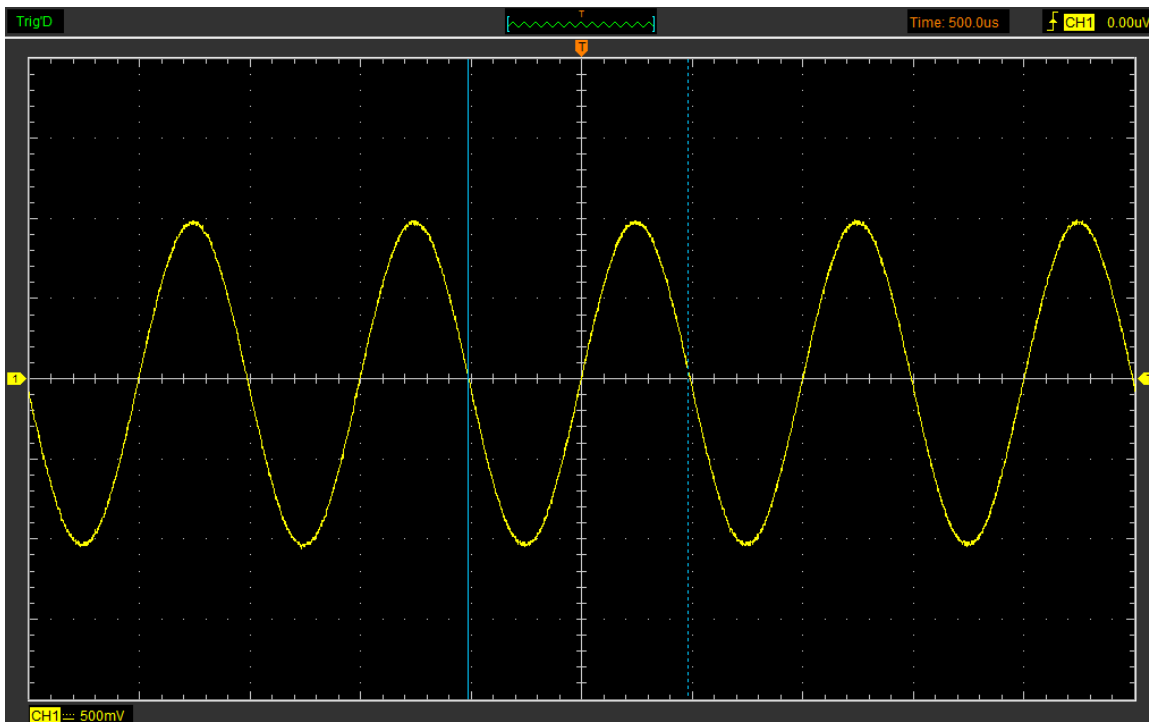

The **Vertical** cursor measure result display on status bar

Freq: 1.004KHz Time: 996uS

4) Horizontal

The **Horizontal** cursors appear as horizontal lines on the display and measure the horizontal parameters.

The **Horizontal** cursor display window:

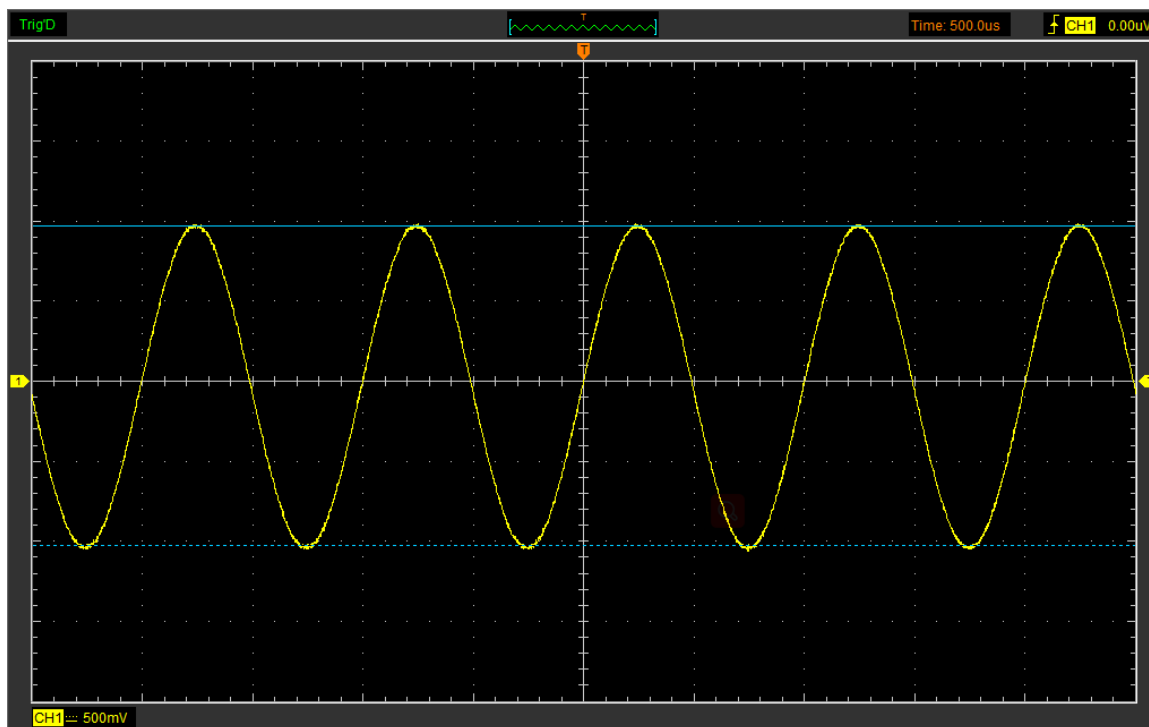

The **Horizontal** cursor measure result display on status bar:

Volt: 2.00V

3.9.2 Measure Menu

Click "**More->Measure**" menu.

The oscilloscope provides 20 parametric auto measurements (12 voltage and 8 time measurements).

1. Source

The user can use the "**Source**" menu to select a measure source.

2. Vertical

Maximum: Voltage of the absolute maximum level, Measured over the entire waveform

Minimum: Voltage of the absolute minimum level, Measured over the entire waveform

Peak To Peak : Peak-to-peak = Max –Min, Measured over the entire waveform

Top: Voltage of the statistical maximum level, Measured over the entire waveform

Base: Voltage of the statistical minimum level, Measured over the entire waveform

Middle: Voltage of the 50% level from base to top

RMS: The Root Mean Square voltage over the entire waveform

Amplitude: Amp = Base - Top, Measured over the entire waveform

Mean: The arithmetic mean over the entire waveform

Cycle Mean: The arithmetic mean over the first cycle in the waveform

Preshoot: Positive Overshoot = $(\text{Max} - \text{Top})/\text{Amp} \times 100\%$, Measured over the entire waveform

Overshoot: Negative Overshoot = $(\text{Base} - \text{Min})/\text{Amp} \times 100\%$, Measured over the entire waveform.

3. Horizontal

Period: Time to take for the first signal cycle to complete in the waveform

Frequency: Reciprocal of the period of the first cycle to complete in the waveform

Rise Time: Time taken from lower threshold to upper threshold

Fall Time: Time taken from upper threshold to lower threshold

+Duty Cycle: Positive Duty Cycle = $(\text{Positive Pulse Width})/\text{Period} \times 100\%$, Measured of the first cycle in waveform.

-Duty Cycle: Negative Duty Cycle = $(\text{Negative Pulse Width})/\text{Period} \times 100\%$, Measured of the first waveform.

+Pulse Width: Measured of the first positive pulse in the waveform. The time between the 50% amplitude points

-Pulse Width: Measured of the first negative pulse in the waveform. The time between the 50% amplitude points

4. Clear Measure

Clear all measure items on display screen.

The **Measure** Display Window:

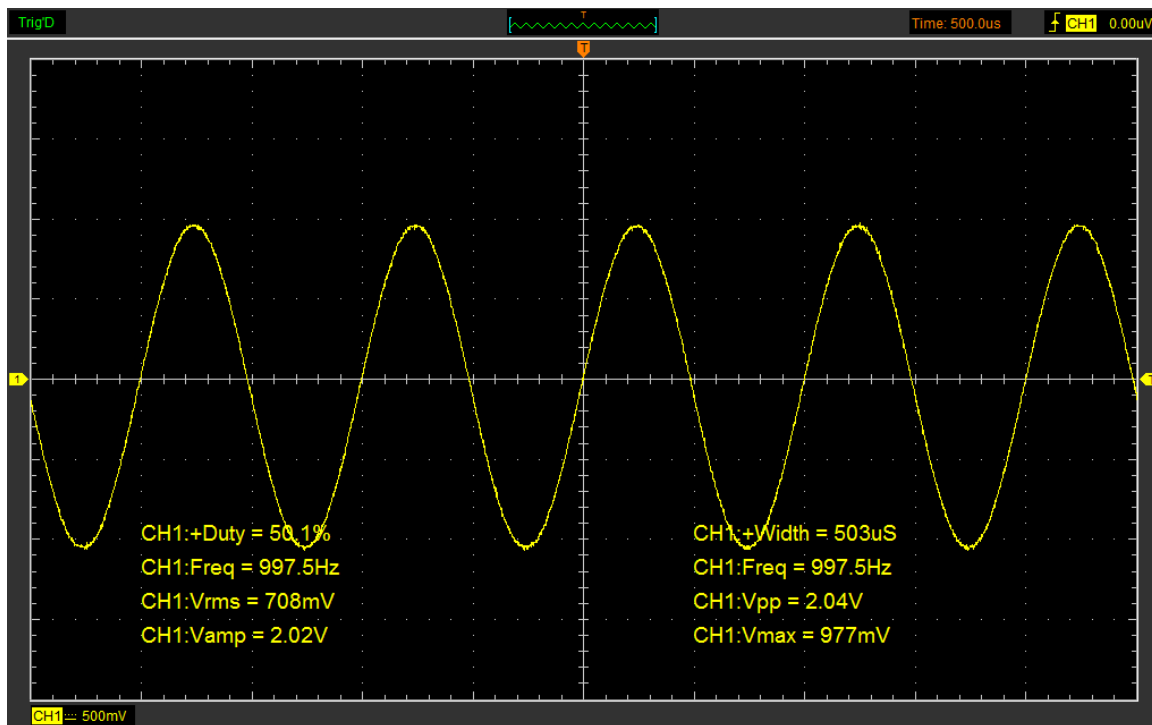

Note: The results of the automatic measurements will be displayed on the bottom of the screen. Maximum 8 results could be displayed at the same time. When there is no room, the next new measurement result will make the previous results moving left, out of screen.

3.10 Display System

Display Type

Click “**More->Display->Type**” menu.

The following figure shows the type parameters setting.

If the **Vectors** type mode is selected, the waveform will be displayed as following figure.

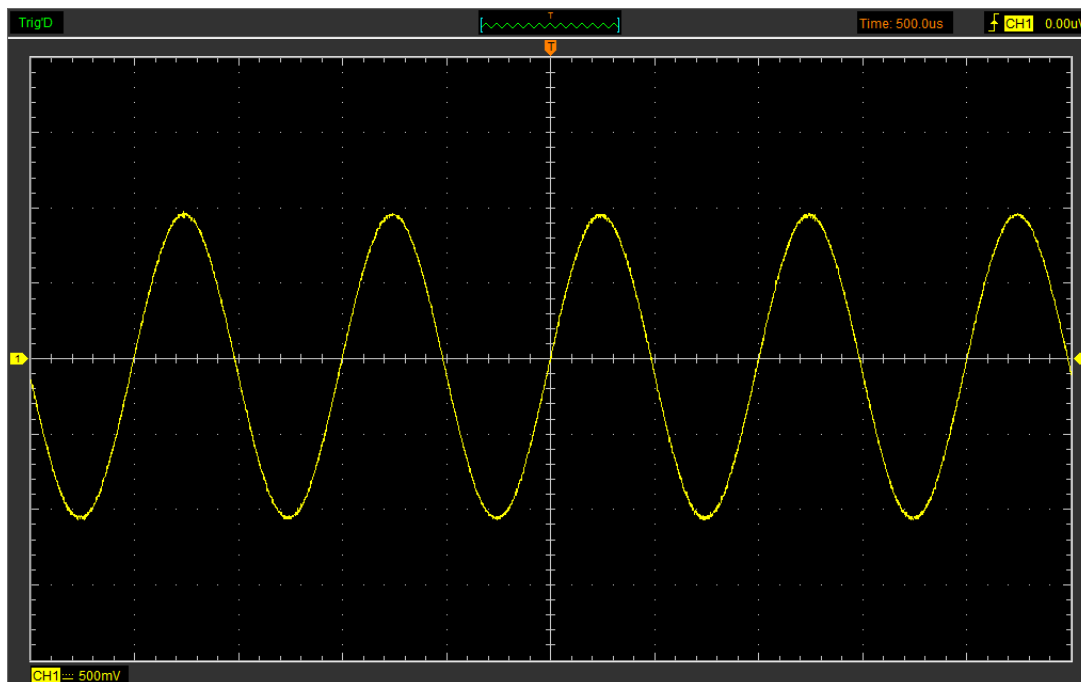

If the **Dots** type mode is selected, the waveform will be displayed as following figure.

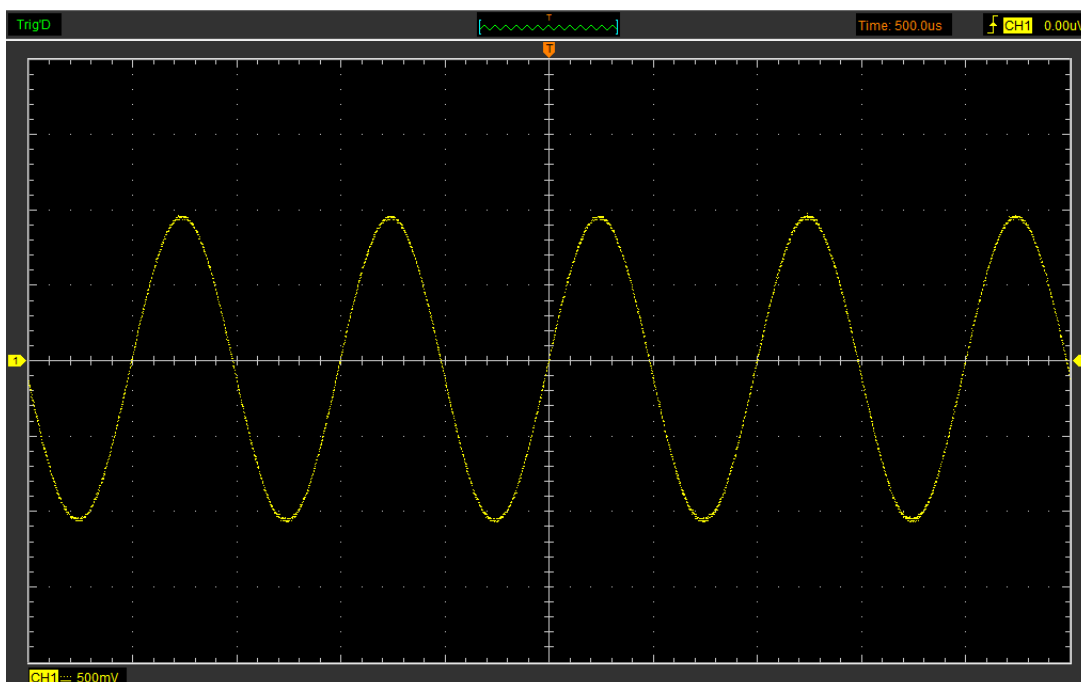

Display Grid

Click **“More->Display->Grid”** in main menu

The grid shows:

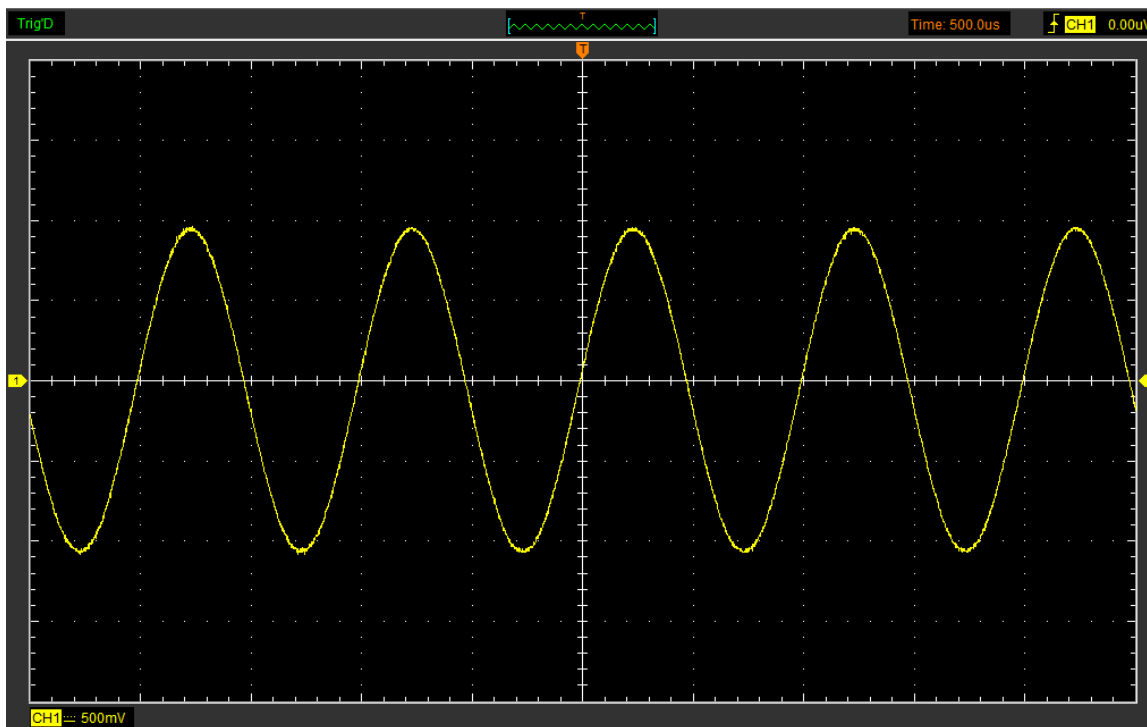

Without grid not shows:

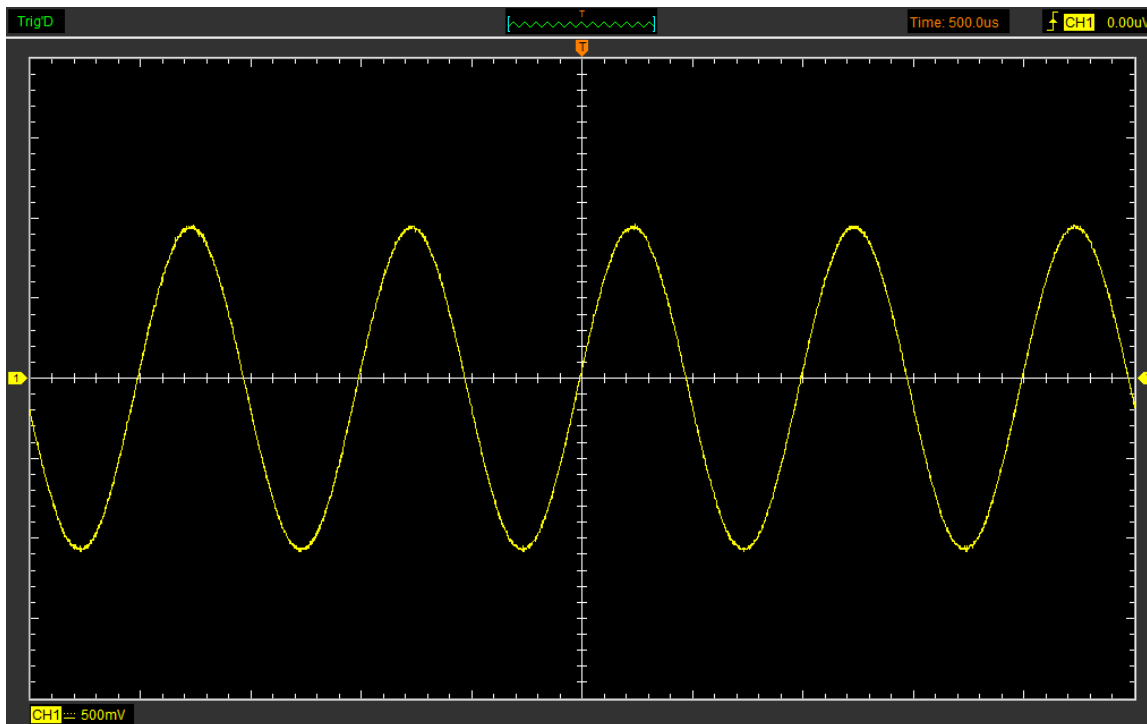

Intensity

Click “**Display->Intensity**” in main menu.

The following figure shows the intensity dialog. It shows the display parameters setting.

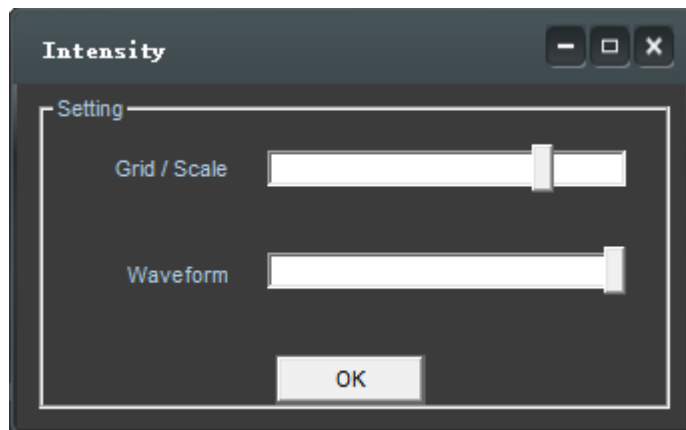

You can change the grid and waveform intensity in this dialog.

3.11 Zoom In/Out

The software will stop updating waveform after the user clicked “**Stop**” button. The user can change the waveform display by adjusting the scale and position. When you change the scale, the waveform display will increase or decrease in size. When you change the position, the waveform will move up, down, right, or left.

The channel reference indicator identifies each waveform on the display. The indicator points to the reference level of the waveform record.

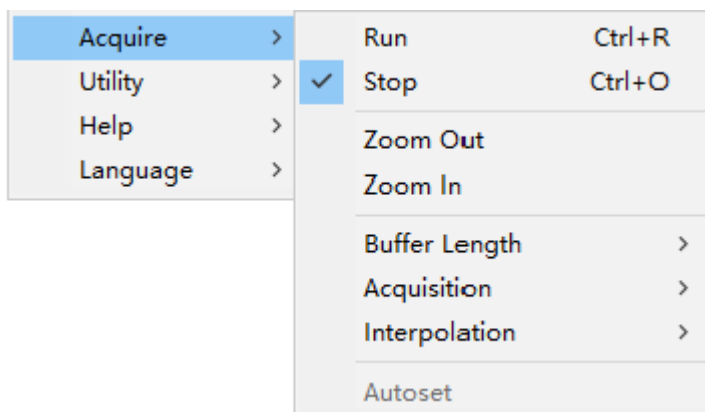

Zoom In/Out

The user can click “**Zoom In/Out**” in “**Acquire**” menu, then left or right click the mouse button on display screen to **zoom in/out** the waveform. Also the user can change **Time/Div** in **Horizontal** menu or in **Horizontal** panel to zoom in/out the waveform.

3.12 Print and Print Preview

Click "File" in main menu.

1. Click "**More->File->Print**" menu to set the printer to print the current waveform.
2. Click the "**More->File->PrintPreview**" menu to get into the Preview window.

In "**PrintPreview**" window, use the "**Zoom In**" button and the "**Zoom Out**" button to change the size of the waveform graph. Click the "**Close**" button to turn this window off and click the "**Print**" button to print the report.

The Print Report:

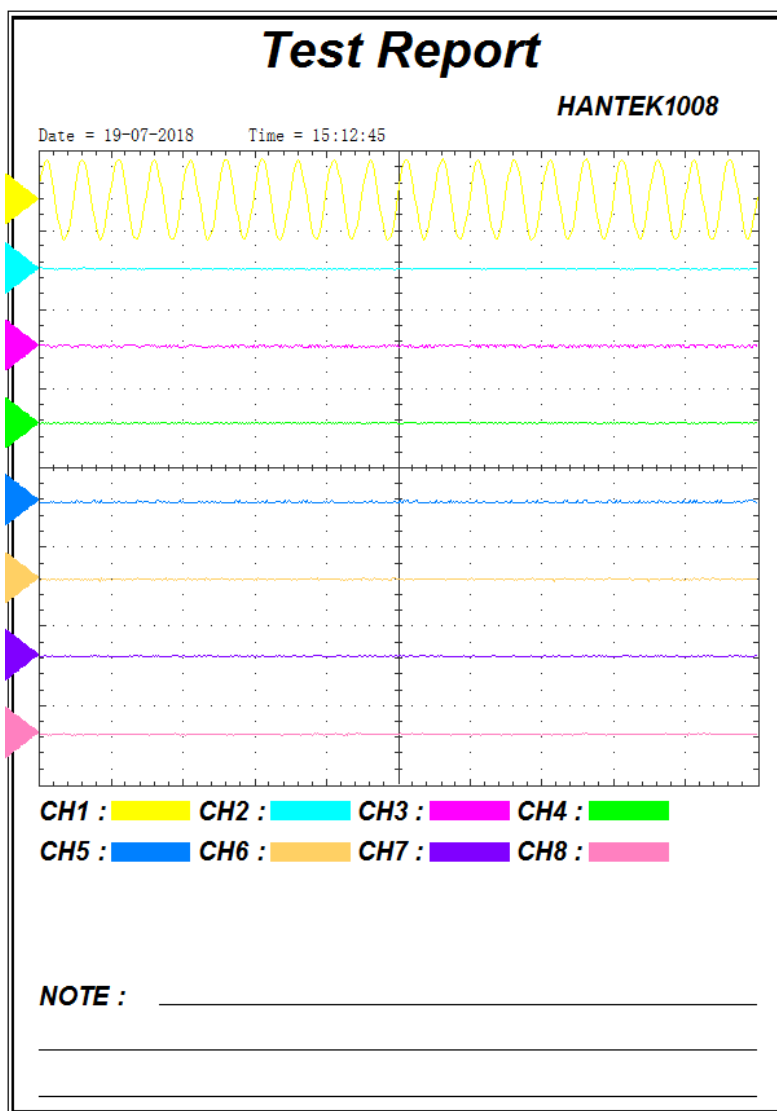

3.13 Generate Square Waveform

Click “ -> **Generator**” to Generator setting.

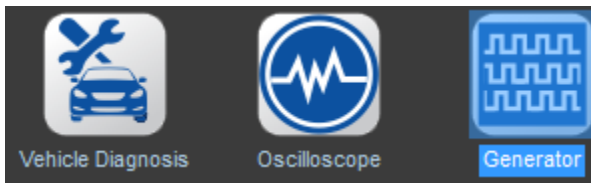

The following dialog will display:

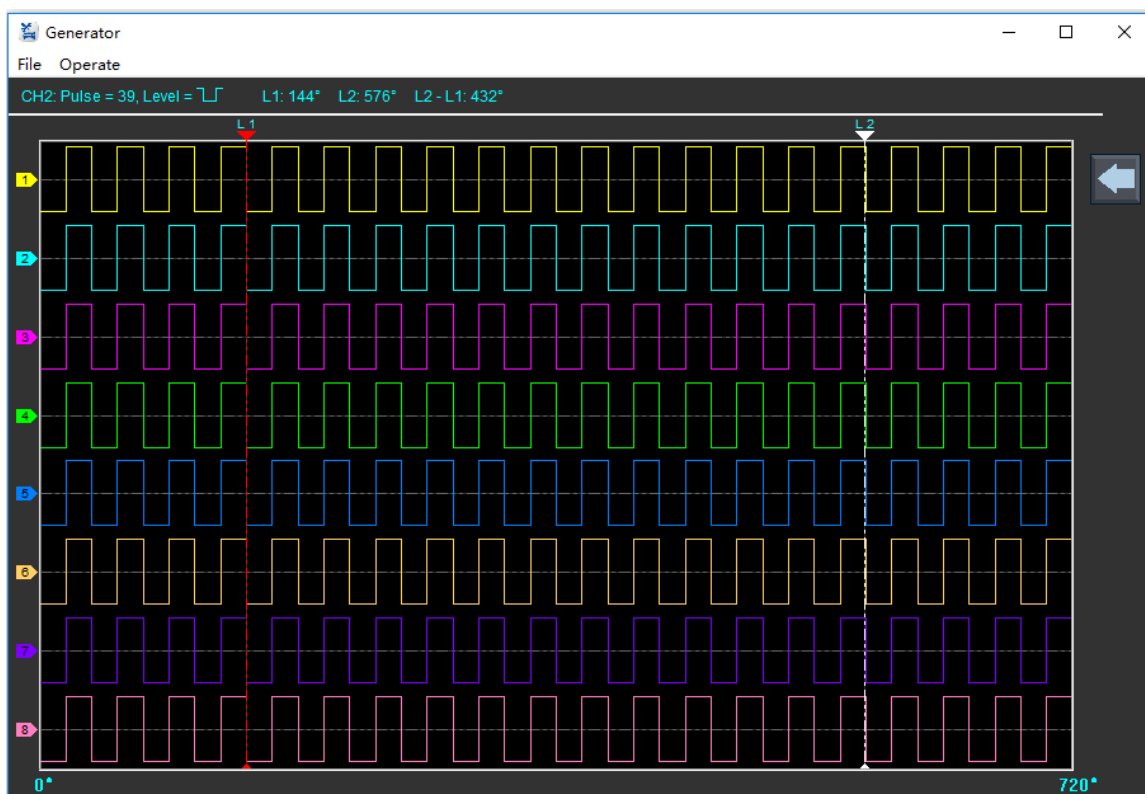

1. Edit Setting

Click “**Edit->Edit On**” to open edit setting.

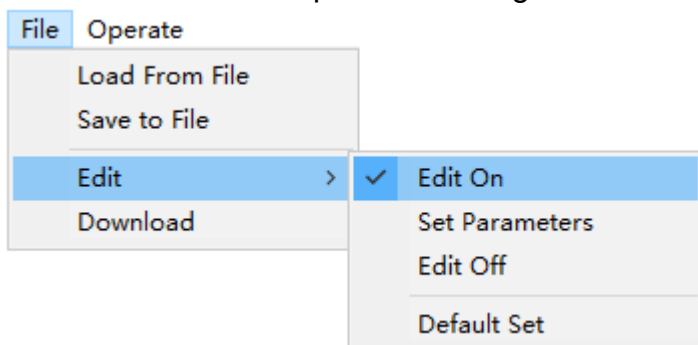

Click **"Edit->Set Parameters"** to set waveform parameters.

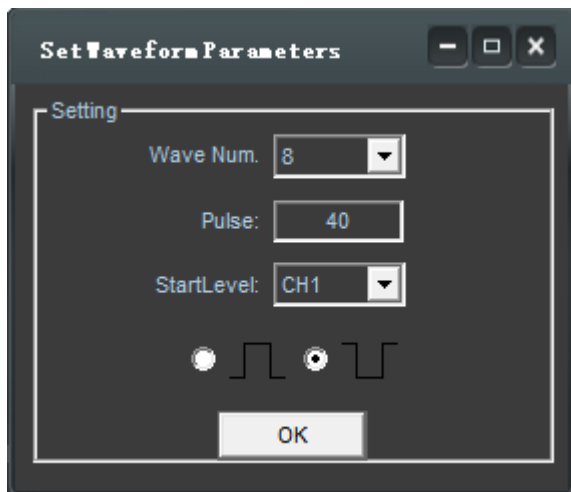

Wave Num: The number of waveform channels, you can set it as 3, 5 or 8.

Pluse: Setting pluse number.

StartLevel: Setting the start level (High or Low) of channels.

To change the pulse width, please click **"File->Edit->Edit On"**. Then click left mouse to change the pulse width.

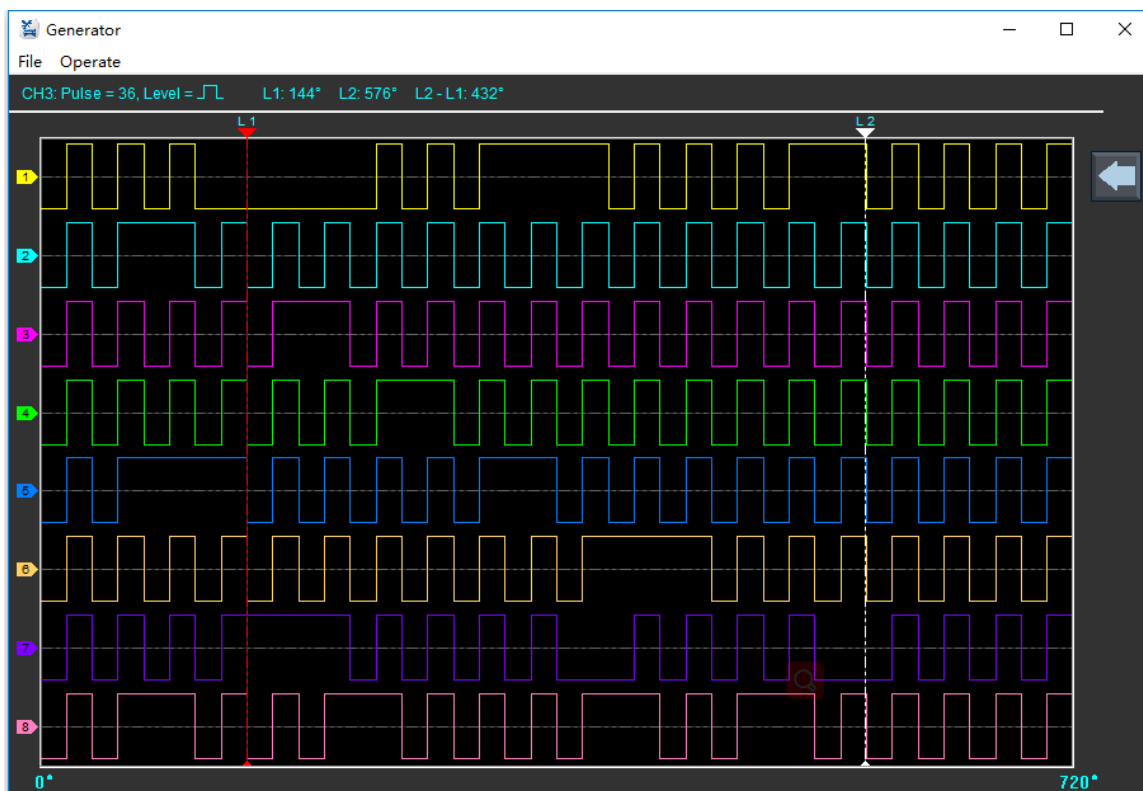

2. Output Waveform

1. Click “Operate->Output->ON”.

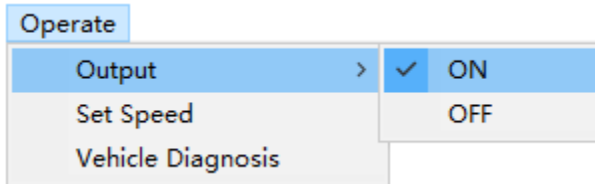

2. Click “File->Download”.

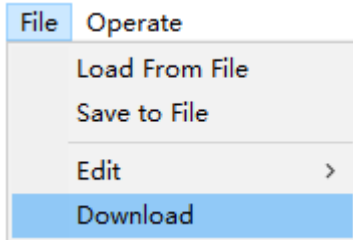

3. Connect D0~D7 digital channels to output waveform.

Chapter 4 Application Example

- ◆ **Simple Measurement**
- ◆ **Capturing a Single-Shot Signal**
- ◆ **The Application of the X-Y**
- ◆ **Taking Cursor Measurement**

4.1 Simple Measurement

To acquire and display a signal, please do the steps as follows:

1. Connect signal to **CH1** by using probe.
2. Adjust the vertical and horizontal controls to meet your measurement to optimize the waveform display.

To measure the **Frequency** and “**Vpp**”, you can do these steps as follows:

1. Click the “**More->Measure->Horizontal->Frequency**” button, the frequency of the signal display on the bottom of the waveform interface.
2. Click the “**More->Measure->Vertical->Peak-to-Peak**” button, the “**Vpp**” of the signal will also display on the bottom of the waveform interface.

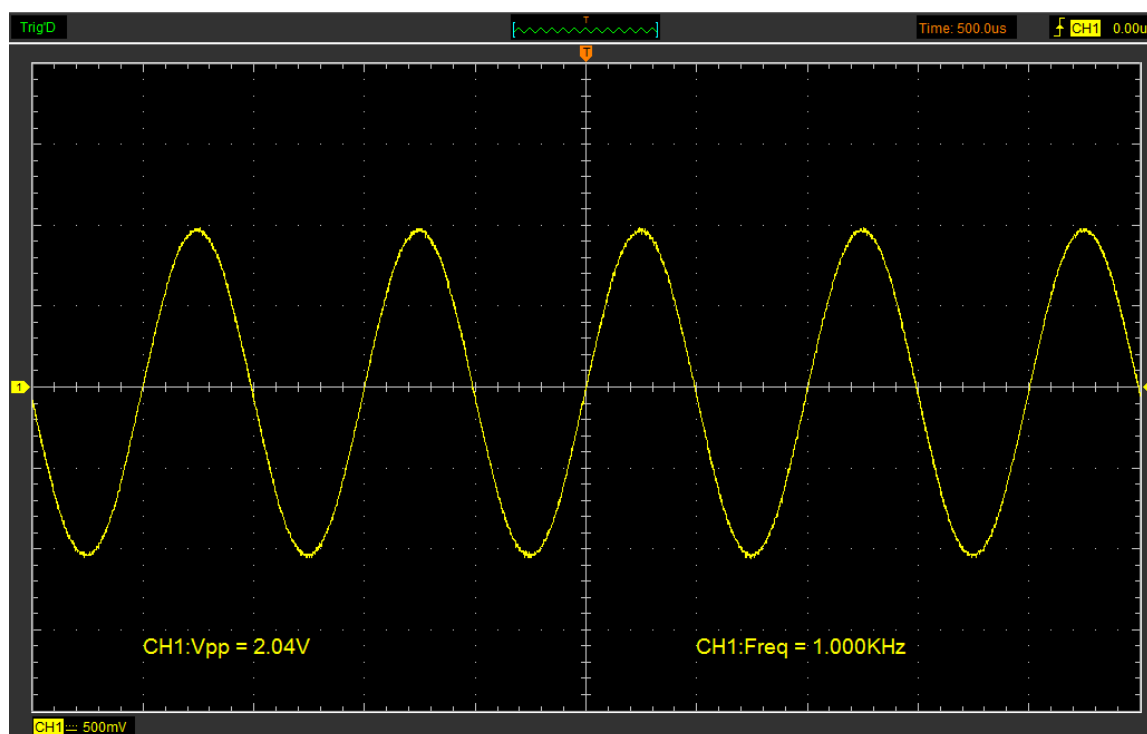

3. To clear the measurement on the waveform interface, click the “**More->Measure->Clear Measure**” button.

4.2 Capturing a Single-Shot Signal

To capture a single event, it needs to gather some pre-test knowledge of the signal in order to set up the trigger level and slope correctly. For example, if the event is derived from 3.3V COMS logic, a trigger level of 1.2 or higher Volts should work on a rising edge. Do these steps as follows:

1. Set the probe and the channel attenuations to X 10.
2. Set up the trigger in the Trigger Menu.
 - 1) Adjust the Trigger Mode to Edge.
 - 2) Set the Trigger Sweep to Single.
 - 3) Set the Trigger Source to CH1.
 - 4) Set the Trigger Slope to “+” which means you select the rising edge.
 - 5) Adjust the Volts/Div and the time base in a proper range for the signal.
 - 6) Drag the trigger level sign  on the waveform display screen to proper position. It's usually higher a little above the normal level.
 - 7) Click **Run** button to start capturing. When the trigger conditions are met, data appears on the display representing the data points that the oscilloscope obtained with one acquisition.

This function helps to capture the signal occurrence easily, such as the noise with large amplitude; set the trigger level higher a little above the normal level and press and wait. When noise occurs, the instrument will record the waveform before and after the trigger.

4.3 The Application of the X-Y Operation

X-Y Plot acts to analyze correlation of data of two channels. Lissajous diagram is displayed in the screen when you use **X-Y** Plot, which enables to compare frequencies, amplitudes and phases of counterpart waveform against the reference waveform. This makes it possible to compare and analyze frequency, amplitude and phase between input and output.

Do these steps as follows:

1. Set the probe attenuation to “**x10**”. Set the switch to “**x10**” on the probes.
2. Connect the CH1 probe to the input of the circuit, and connect the CH2 probe to the output of the circuit.
3. Adjust the vertical scale and offset to display approximately the same amplitude signals on each channel.

4. Select X-Y format at Horizontal window. The oscilloscope will displays a Lissajous pattern representing the input and the output characteristics of the circuit.
5. Adjust the scale and offset of the horizontal and vertical to a desirable waveform display. The following picture shows a typical example.
6. Apply the Ellipse Method to observe the phase difference between the two channels.

Signal in X-Y Format:

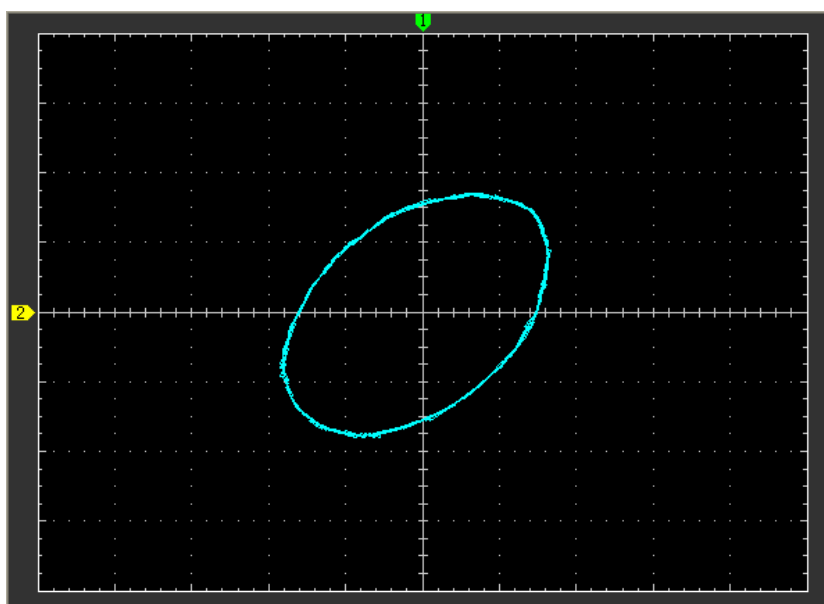

Instruction of the Ellipse Method

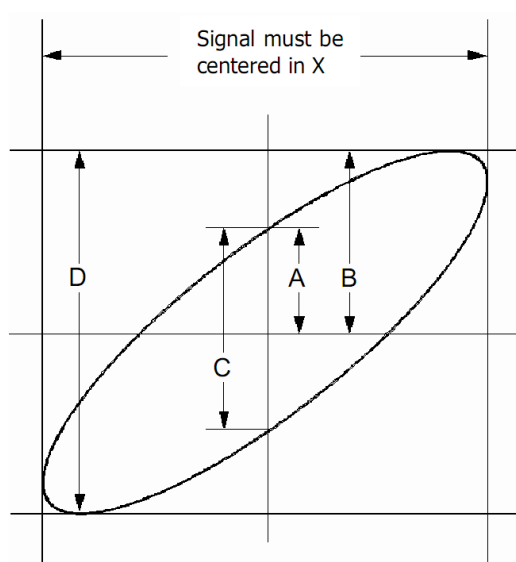

$\sin\theta = A/B$ or C/D , where θ = phase shift (in degrees) between the two signals.
From the formula above:

$$\theta = \pm \arcsine (A/B) \text{ or } \pm \arcsine (C/D)$$

θ must be in the range of $(0 \sim \pi/2)$ or $(3\pi/2 \sim 2\pi)$ if the main axis of the ellipse is

between I and III quadrant, . If the main axis is at II and IV quadrant, θ must be in the range of $(\pi/2 \sim \pi)$ or $(\pi \sim 3\pi/2)$.

4.4 Taking Cursor Measurements

Use cursors to make time and amplitude measurements on a waveform quickly.

Measure the Peak Frequency or Time of the First Sine Waveform

Do these steps:

1. Click **"More->Cursor->Source"**, select CH1 (select CH2~CH8 if you want measure CH2~CH8).
2. Click **"More->Cursor->Type"**, select Vertical.
3. Push left mouse button, and the vertical lines appear.
4. Drag the mouse button to the point you want to measure.
5. Release the left mouse button, the frequency difference and time difference will be shown at the status bar.

Measure the Frequency and Time:

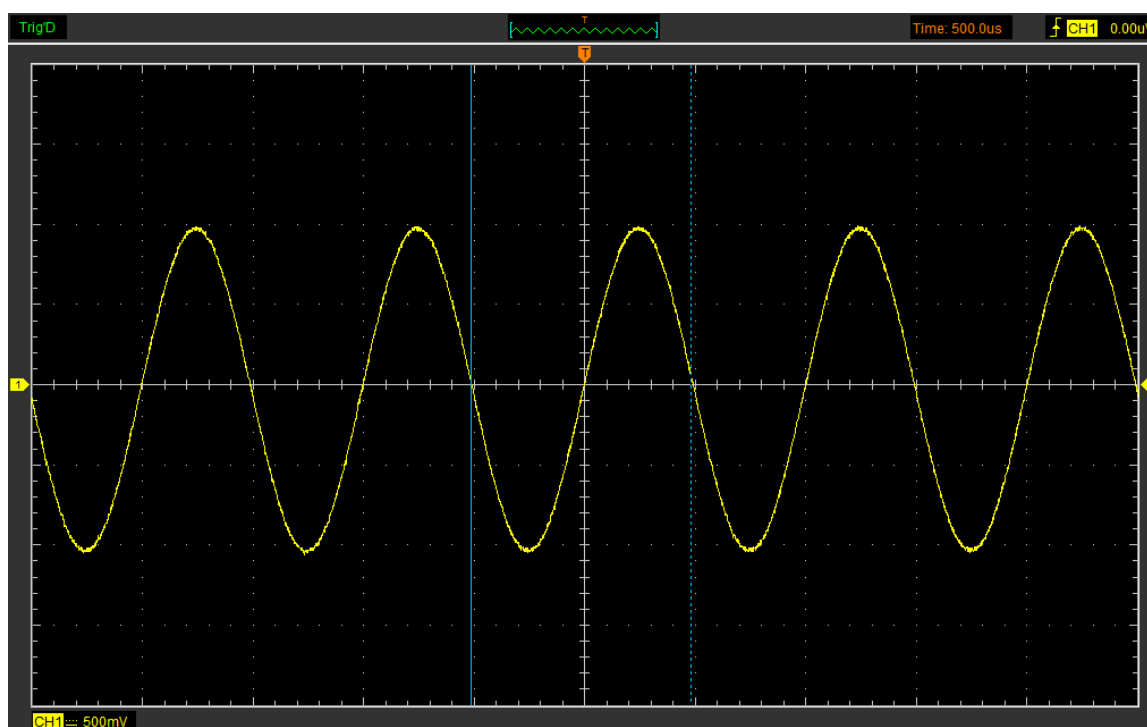

Read the details showing in the status bar.

Freq: 1.004KHz Time: 996uS

Measure the Amplitude of the First Waveform Peak of the Waveform

Do these steps:

1. Click **“More->Cursor->Source”**, select CH1 (select other CH if you want measure other CH).
2. Click **“More->Cursor->Type”**, select Horizontal.
3. Push left mouse button, and the Horizontal lines appear.
4. Drag the mouse button to the point you want to measure.
5. Release the left mouse button, the voltage difference will be shown at the status bar.

Measure the Amplitude:

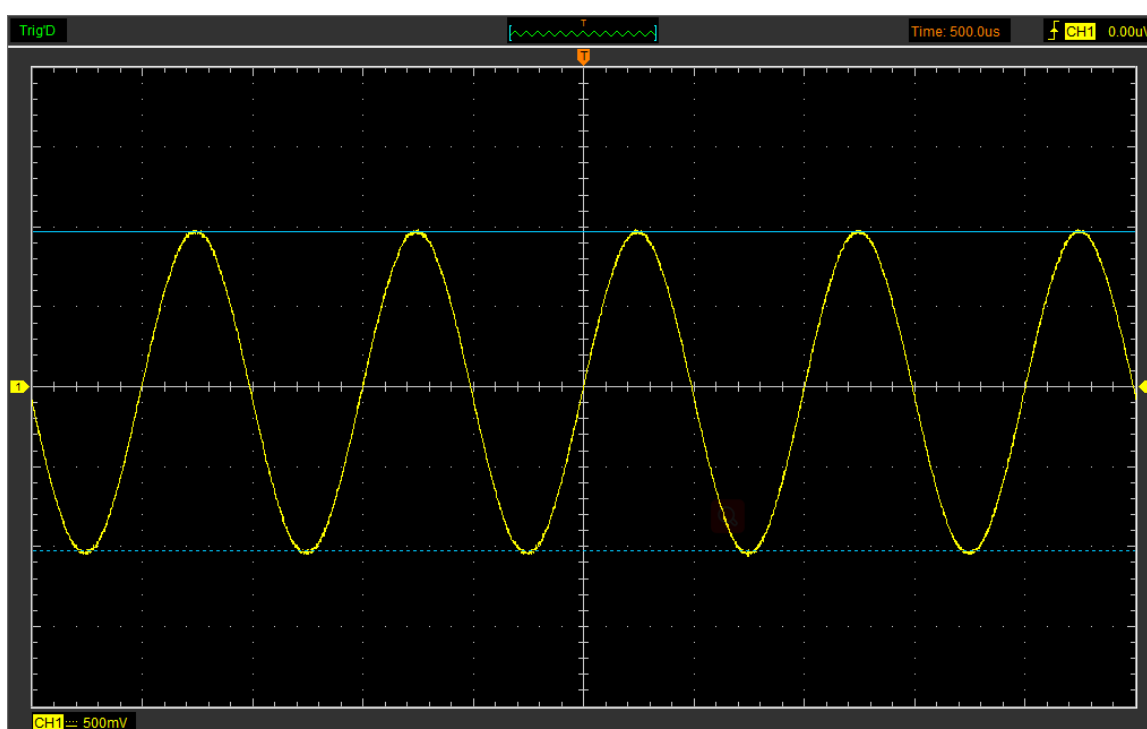

Read the details showing in the status bar.

Volt: 2.00V

Trace the Amplitude of a fixed position on X-axis in a Waveform

Do these steps:

1. Click **“More->Cursor->Source”**, select CH1 (select other CH if you want trace other CH).
2. Click **“More->Cursor->Type”**, select Trace.
3. Click the cursor at the position that you want traced of the wave in the waveform window.

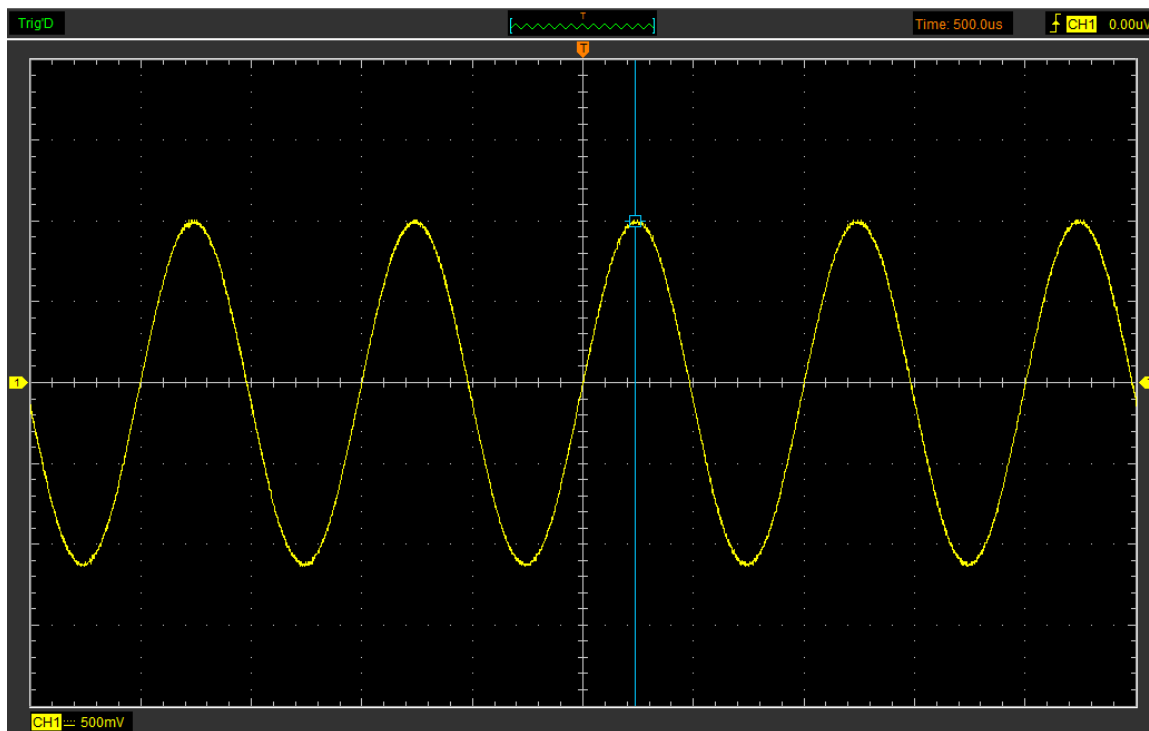
Trace the Amplitude:

Read the details showing in the status bar.

Volt: 997mV

Note: Click “More->Cursor->Type”, select “Cross”, you can measure time and amplitude at one time.

Appendix

- ◆ **Appendix A: Specifications**
- ◆ **Appendix B: General Maintenance**

Appendix A: Specifications

Specifications Table:

| Acquisition | |
|--------------------|--------------------------|
| Acquisition Mode | Real-Time Sample |
| Acquisition Rate | 2.4MSa/s(Single Channel) |

| Input | |
|---------------------------------------|------------------------------------|
| Bandwidth | 100K(Single Channel) |
| Input Coupling | DC |
| Input Impedance | Resistance: 1M Ω |
| Supported Voltage Attenuation Factors | 1X, 10X, 100X, 1000X, 10000X, 20:1 |
| Maximum Input Voltage | 400Vpk (DC + peak) |

| Horizontal | |
|-------------------------------------|--|
| Scanning Speed Range(Sec/Div) | 1ns/div ~ 20000s/div(1-2-5 sequences) |
| Sample Rate and Delay Time Accuracy | ± 50 ppm(any interval ≥ 1 ms) |
| Memory Depth(Sample Points) | Max.4K(Single Channel) |

| Vertical | |
|--------------------------------|---|
| Analog Channel | 8 |
| A/D converter | 12 bit |
| Vertical Scale(Volt/div) Range | 10mV ~ 5V/div @ x1 probe(1,2,5 sequence) 100mV ~ 50V/div @ x10 probe 1V ~ 500V/div @ x100 probe 10V ~ 5000V/div @ x1000 probe 100V ~ 50000V/div @ x10000 probe 200mV ~ 100V/div 20:1 probe |
| DC Gain Accuracy | $\pm 3\%$ |
| Trigger | |
| Trigger Source | CH1-CH8 |
| Trigger Mode | Auto, Normal and Single |
| Trigger Type | Edge |
| Trigger Sensitivity | 0.02 div increments |
| Trigger Level Accuracy | ± 4 divisions |

| Measurement | |
|--------------------|---|
| Cursor | Amplitude difference between cursors (ΔV) Time difference between cursors (Δt) Reciprocal of Δt in Hertz ($1 / \Delta t$) (Cross, Trace, Horizontal, Vertical) |
| Auto Measure | Voltage Measurement Vp-p, Vmax, Vmin, Vmean, Vamp, Vtop, Vbase, Vmid, Vrms, Vcrms, Preshoot, Overshoot |
| | Time Measurement Frequency, Period, Rise Time(10%~90%), Fall Time(10%~90%), Positive Width, Negative Width, Duty Cycle |

| Programmable Square Generator | |
|--------------------------------------|----------|
| Channel | 8(D0-D7) |
| Output Level | LVTTL |
| Frequency Range | 0-250KHz |

Appendix B: General Maintenance

General Care

Do not store or leave the oscilloscope where the device will be exposed to direct sunlight for long periods of time.

Caution

To avoid damages to the device or probes, do not expose them to sprays, liquids or solvents.

To avoid damages to the surface of the device or probes not use any abrasive or chemical cleaning agents.

Cleaning

Inspect the device and probes as often as operating conditions require. Make sure the device disconnect form all power sources.

To clean the exterior surface, perform the following steps:

1. Remove loose dust on the outside of the oscilloscope and probes with a lint-free cloth. Use care to avoid scratching the clear glass display filter.
2. Use a soft cloth dampened with water to clean the device.