

**DSO8000E SERIES
HANDHELD OSCILLOSCOPE**

USER'S MANUAL
8072E/8102E/8152E/8202E
(V1.0.3)



Contents

Contents	i
Copyright Declaration.....	iv
Chapter 1 Safety Tips.....	1
1.1 General Safety Summary	1
1.2 Safety Terms and Symbols	1
1.3 Terms on Product.....	2
1.4 Symbols on Product.....	2
1.5 Product Scrapping	2
Chapter 2 Overview.....	3
2.1 Brief Introduction to DSO8000E Series	3
2.2 Help System.....	3
Chapter 3 Getting Started Guide	4
3.1 Installation.....	4
3.2 Functional Check	4
3.2.1 Power on the oscilloscope.....	4
3.2.2 Connect the oscilloscope	4
3.2.3 Observe the waveform	5
3.3 Probe Examination.....	5
3.3.1 Safety.....	5
3.3.2 Use of Probe Check Wizard	6
3.4 Manual Probe Compensation	6
3.5 Probe Attenuation Setting	7
3.6 Self Calibration.....	7
Chapter 4 Main Feature Description	8
4.1 Oscilloscope Setup	8
4.2 Trigger.....	8
4.3 Data Acquisition	9
4.4 Waveform Scaling and Positioning.....	10
4.5 Waveform Measurement.....	11
Chapter 5 Basic Operation	12
5.1 DisplayArea.....	13
5.1.1 XY Format.....	15
5.2 Horizontal Controls	16
5.2.1 Scan Mode Display (Roll Mode).....	18
5.3 Vertical Controls.....	18
5.3.1 Math FFT	20
5.4 Trigger Controls	25
5.5 Menu and Option Buttons.....	31
5.5.1 SAVE/RECALL	31

5.5.2	MEASURE	32
5.5.3	UTILITY	34
5.5.4	DISPLAY	35
5.5.5	ACQUIRE	36
5.5.6	CURSOR	37
5.6	Fast Action Buttons	38
5.6.1	AUTOSET	38
5.7	Signal Connectors.....	40
Chapter 6	Application Examples	41
6.1	Example 1: Taking Simple Measurements	41
6.2	Example 2: Taking Cursor Measurements.....	43
6.3	Example 3: Analyzing Input Signals to Eliminate Random Noise	46
6.4	Example 4: Capturing Single-shot Signal.....	47
6.5	Example 5: Using X-Y Mode.....	48
6.6	Example 6: Triggering on Pulse Width	49
6.7	Example 7: Triggering on Video Signal	50
6.8	Example 8: Using Slope Trigger to Capture Particular Slope Signal	52
6.9	Example 9: Using Overtime Trigger to Measure Long Pulse Signal	53
6.10	Example 10: Using Math Functions to Analyze Waveforms.....	54
6.11	Example 11: Measuring Data Propagation Delay.....	55
6.12	Example 12: Back light control	56
6.13	Example 13: Auto shut down	57
6.14	Example 14: Setting Net IP	57
6.15	Example 15: Charging	58
Chapter 7	Multimeter.....	60
Chapter 8	Recorder	69
8.1	Multimeter Trend.....	70
8.2	Oscilloscope Trend	71
8.3	Waveform Recorder.....	72
Chapter 9	Waveform Generator	75
9.1	Waveform Generator	75
9.2	Edit Arb waveform.....	77
Chapter 10	Troubleshooting.....	80
10.1	Problem Settlement	80
Chapter 11	Specifications.....	81
11.1	Technical Specifications.....	81
11.2	Accessories	87
Chapter 12	General Care and Cleaning.....	88
12.1	General Care	88
12.2	Cleaning.....	88

Chapter 13 Services and Support..... 89
Appendix A Harmful and Poisonous Substances or Elements..... 90

Copyright Declaration

All rights reserved; no part of this document may be reproduced or transmitted in any form or by any means, electronic or mechanical, without prior written permission from Qingdao Hantek Electronic Co., Ltd (hereinafter referred to as 'Hantek').

Hantek reserves all rights to modify this document without prior notice. Please contact Hantek for the latest version of this document before placing an order.

Hantek has made every effort to ensure the accuracy of this document but does not guarantee the absence of errors. Moreover, Hantek assumes no responsibility in obtaining permission and authorization of any third party patent, copyright or product involved in relation to the use of this document.

Chapter 1 Safety Tips

1.1 General Safety Summary

Read the following safety precautions to avoid injury and prevent damage to this product or any products connected to it. To evade potential hazards, use this product only as specified.

Only qualified personnel should perform maintenance.

Avoid fire or personal injury.

Connect and disconnect properly. Connect a probe with the oscilloscope before it is connected to measured circuits; disconnect the probe from the oscilloscope after it is disconnected from measured circuits.

Connect the probe in a right way. The probe ground lead is at ground potential. Do not connect the ground lead to an elevated voltage.

Check all terminal ratings. To avoid fire or shock hazard, check all ratings and markings on the product. Refer to the product manual for detailed information about ratings before making connections to the product.

Do not operate without covers. Do not operate this product with covers or panels removed.

Avoid exposed circuitry. Do not touch exposed connections and components when power is present.

Do not operate with suspected failures. If you suspect there is damage to this product, have it inspected by qualified service personnel.

Assure good ventilation.

Do not operate in wet/damp environments.

Do not operate in an explosive atmosphere.

Keep product surfaces clean and dry.

1.2 Safety Terms and Symbols

The following terms may appear in this manual:



WARNING. Warning statements point out conditions or practices that could result in injury or loss of life.



CAUTION. Caution statements identify conditions or practices that could result in damage to this product or other property.

1.3 Terms on Product

The following terms may appear on the product:

DANGER indicates an injury hazard immediately accessible as you read the marking.

WARNING indicates an injury hazard not immediately accessible as you read the marking.

CAUTION indicates a possible hazard to this product or other property.

1.4 Symbols on Product

The following symbols may appear on the product:

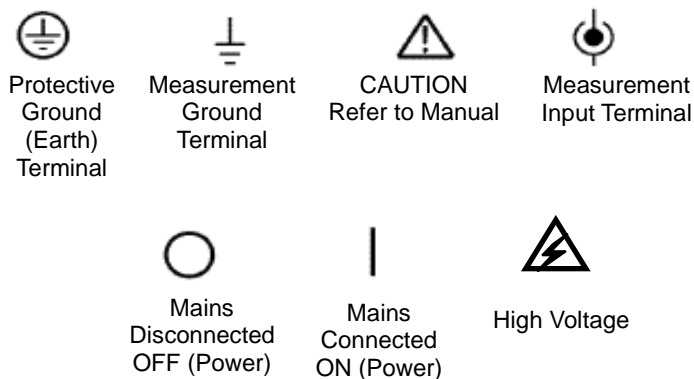

1.5 Product Scrapping

Device Recycling

We need extract and utilize natural resources to produce this device. If you do not reclaim the device in a proper way, some substances it contains may become harmful or poisonous to environments or human bodies. To avoid them being released outside and to minimize the waste of natural resources, we suggest you reasonably call back this device to ensure proper recovery and recycling of most materials within it.

Chapter 2 Overview

2.1 Brief Introduction to DSO8000E Series

Model	Channel	Bandwidth	Sample Rate	LCD
DSO8072E	2	70MHz	1GS/s	5.6 TFT
DSO8102E	2	100MHz	1GS/s	5.6 TFT
DSO8152E	2	150MHz	1GS/s	5.6 TFT
DSO8202E	2	200MHz	1GS/s	5.6 TFT

Table 2-1 Model List of DSO8000E Series

DSO8000E Series oscilloscopes cover the bandwidths from 70MHz to 200MHz, and provide the real-time and equivalent sample rates respectively up to 1GSa/s and 25GSa/s. In addition, they have maximum 2M memory depth for better observation of the waveform details, and 5.6 inch color TFT LCD as well as WINDOWS-style interfaces and menus for easy operation.

What's more, the plenty menu information and the easy-to-operate buttons allow you to gain information as much as possible in measurement; the multifunctional and powerful shortcut keys help you save a lot of time in operation; the Autoset function lets you detect sine and square waves automatically; the Probe Check Wizard guides you to adjust the probe compensation and set the Probe option attenuation factor. By using these the methods the oscilloscope provides (context-sensitive, hyperlinks, and an index), you may master all operations on the device in quite a short time so as to greatly improve your efficiency in production and development.

2.2 Help System

This oscilloscope has a Help system with topics covering all of its features. You can use the Help system to display several kinds of information:

- ◆ General information about understanding and using the oscilloscope, such as Using the Menu System.
- ◆ Information about specific menus and controls, such as the Vertical Position Control.
- ◆ Advice to problems you may come across while using an oscilloscope, such as Reducing Noise.

Keep pressing a Function Menu button(including "SAVE/RECALL", "MEAS", "UTILITY", "CURSOR", "CH1", "CH2", "MATH", "HORI" and "TRIG") for 3s to turn on the help file for the function.

Chapter 3 Getting Started Guide

3.1 Installation

To keep proper ventilation of the oscilloscope in operation, leave a space of more than 5cm away from the top and the two sides of the product.

3.2 Functional Check

Follow the steps below to perform a quick functional check to your oscilloscope.

3.2.1 Power on the oscilloscope

Press the ON/OFF button. The default Probe option attenuation setting is 10X.



The default probe parameter

3.2.2 Connect the oscilloscope

Set the switch on the probe to 1X and connect the probe to Channel 1 on the oscilloscope. First, align the slot in the probe connector with the protuberance on the CH1 BNC and push to connect; then, turn to right to lock the probe in place; after that, connect the probe tip and reference lead to the PROBE COMP connectors. The Probe COMP: ~2V@1KHz.



3.2.3 Observe the waveform

Press the AUTO button and you should see within a few seconds a square wave of about 2V peak-to-peak at 1kHz in the display. Press the CH1 MENU button and remove Channel 1. Push the CH2 MENU button and repeat Step 2 and Step 3 to observe Channel 2.

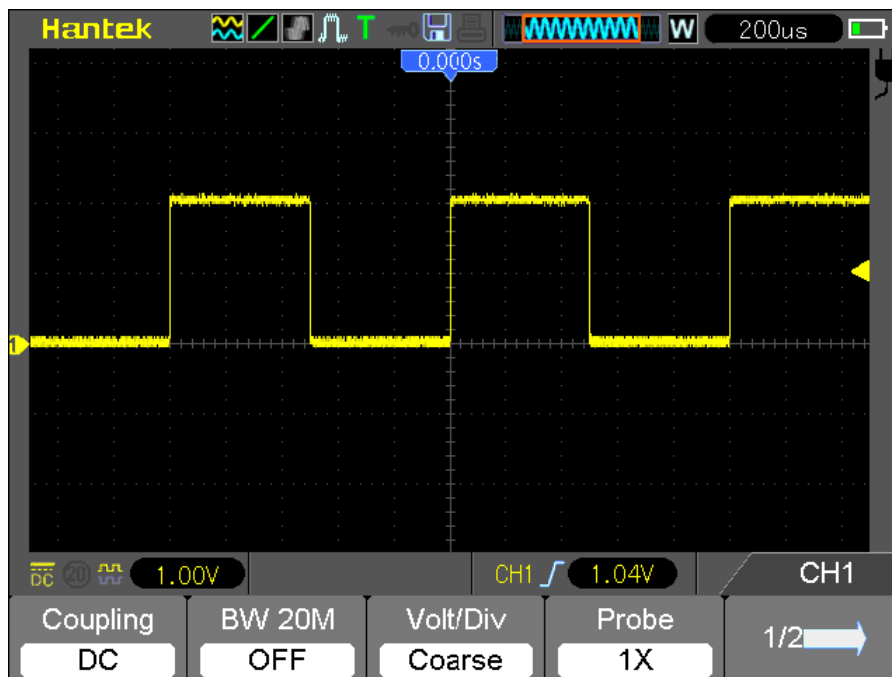

3.3 Probe Examination

3.3.1 Safety

When using the probe, keep your fingers behind the guard on the probe body to avoid electric shock. Do not touch metallic portions of the probe head while it is connected to a voltage source. Connect the probe to the oscilloscope and connect the ground terminal to ground before you start any measurements.

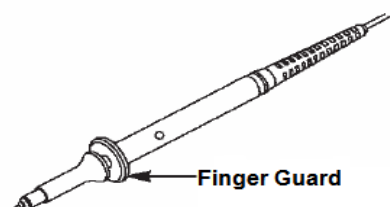

3.3.2 Use of Probe Check Wizard

Every time you connect a probe to an input channel, you should use the probe check wizard to verify that this probe is operating correctly. There are two ways to do this:

- 1) Use the vertical menu (for example, push the CH1 MENU button) to set the Probe option attenuation factor.
- 2) Press UTILITY key and turn to 3/5 page and then press the Probe CK key to use the Probe Check Wizard and configure the probe option attenuation factor properly following menu prompts.

3.4 Manual Probe Compensation

Upon the first connection of a probe and an input channel, you should manually perform this adjustment to match the probe to the input channel. Uncompensated or miscompensated probes may lead to errors or faults in measurement. To adjust the probe compensation, follow the steps below.

1. Set the Probe option attenuation in the channel menu to 10X. Set the switch on the probe to 10X and connect the probe to Channel 1 on the oscilloscope. If you use the probe hook-tip, ensure it is firmly inserted onto the probe. Attach the probe tip to the PROBE COMP ~2V@1KHz connector and the reference lead to the PROBE COMP Ground connector. Display the channel and then press the AUTO button.
2. Check the shape of the displayed waveform.

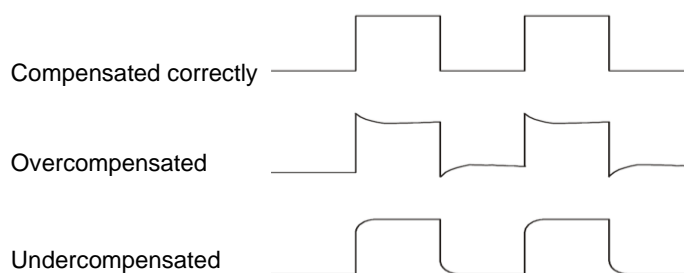

3. If necessary, use a nonmetallic screwdriver to adjust the variable capacity of your probe until the shape of the waveform turns to be the same as the above figure. Repeat this step as necessary. See the figure below for the way of adjustment.

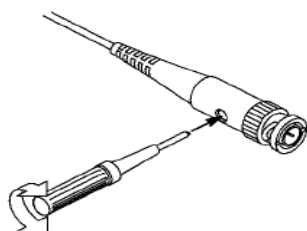

3.5 Probe Attenuation Setting

Probes are of various attenuation factors which affect the vertical scale of the signal. The Probe Check function is used to verify if the Probe attenuation option matches the attenuation of the probe.

As an alternative method to Probe Check, you can push a vertical menu button (such as the CH 1 MENU button) and select the Probe option that matches the attenuation factor of your probe.

Make sure that the Attenuation switch on the probe matches the Probe option in the oscilloscope. Switch settings are 1X and 10X.

When the Attenuation switch is set to 1X, the probe limits the bandwidth of the oscilloscope to 6MHz. To use the full bandwidth of the oscilloscope, be sure to set the switch to 10X.

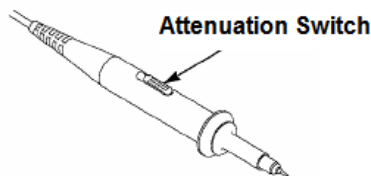

3.6 Self Calibration

The self calibration routine helps optimize the oscilloscope signal path for maximum measurement accuracy. You can run the routine at any time but should always run it if the ambient temperature changes by 5°C or more. For a more accurate calibration, please power on the oscilloscope and wait for 20 minutes until it has adequately warmed up.

To compensate the signal path, disconnect any probes or cables from the front-panel input connectors. Then, push the UTILITY button, select the Self Cal option and follow the directions on the screen.

Chapter 4 Main Feature Description

This chapter provides some general information that you need to learn before using an oscilloscope. It contains:

1. Oscilloscope setup
2. Trigger
3. Data acquisition
4. Waveform scaling and positioning
5. Waveform measurement

4.1 Oscilloscope Setup

While operating the oscilloscope, you may often use the feature: Autoset.

Autoset: This function can be used to adjust the horizontal and vertical scales of the oscilloscope automatically and set the trigger coupling, type, position, slope, level and mode, etc., to acquire a stable waveform display.

4.2 Trigger

The trigger determines when the oscilloscope begins to acquire data and display a waveform. Once a trigger is properly set up, the oscilloscope can convert unstable displays or blank screens to meaningful waveforms. Here introduce some basic concepts about trigger.

Trigger Source: The trigger can be generated with multiple sources. The most common one is the input channel (alternative between CH1 and CH2). Whether the input signal is displayed or not, it can trigger normal operations.

Trigger Type: The oscilloscope has six types of triggers: Edge, Video, Pulse Width, Slope, Overtime and Alter.

- **Edge Trigger** uses the analog or digital test circuits for triggering. It happens when the input trigger source crosses a specified level in a specified direction.
- **Video Trigger** performs a field or line trigger through standard video signals.
- **Pulse Width Trigger** can trigger normal or abnormal pulses that meet trigger conditions.
- **Slope Trigger** uses the rise and fall times on the edge of signal for triggering.
- **Overtime Trigger** happens after the edge of signal reaches the set time.
- **Alter Trigger**, as a feature of analog oscilloscopes, gives stable displays of signals at

two different frequencies. Mainly it uses a specific frequency to switch between two analog channels CH1 and CH2 so that the channels will generate alter trigger signals through the trigger circuitry.

Trigger Mode: You can select the Auto or Normal mode to define how the oscilloscope acquires data when it does not detect a trigger condition. **Auto Mode** performs the acquisition freely in absence of valid trigger. It allows the generation of untriggered waveforms with the time base set to 80ms/div or slower. **Normal Mode** updates the displayed waveforms only when the oscilloscope detects a valid trigger condition. Before this update, the oscilloscope still displays the old waveforms. This mode shall be used when you want to only view the effectively triggered waveforms. In this mode, the oscilloscope displays waveforms only after the first trigger. To perform a **single sequence acquisition**, push the SINGLE SEQ button.

Trigger Coupling: Trigger Coupling determines which part of the signal will be delivered to the trigger circuit. This can help to obtain a stable display of the waveform. To use trigger coupling, push the TRIG MENU button, select an Edge or Pulse trigger, and then select a Coupling option.

Trigger Position: The horizontal position control establishes the time between the trigger position and the screen center.

Slope and Level: The Slope and Level controls help to define the trigger. The Slope option determines whether the trigger point is on the rising or falling edge of a signal. To perform the trigger slope control, press the TRIG MENU button, select an Edge trigger, and use the Slope button to select rising or falling. The LEVEL button controls the trigger point is on which position of the edge.

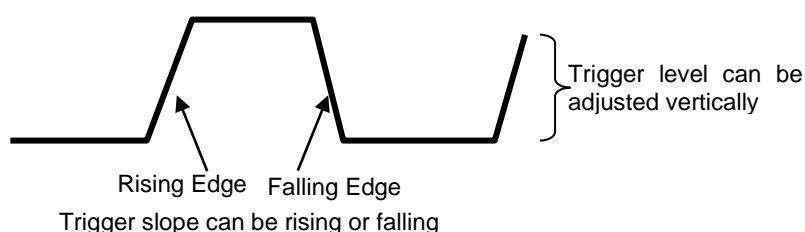

4.3 Data Acquisition

When you acquire an analog signal, the oscilloscope will convert it into a digital one. There are two kinds of acquisition: Real-time acquisition and Equivalent acquisition. The real-time acquisition has three modes: Normal, Peak Detect, and Average. The acquisition rate is affected by the setting of time base.

Normal: In this acquisition mode, the oscilloscope samples the signal in evenly spaced intervals to establish the waveform. This mode accurately represents signals in most time. However, it does not acquire rapid variations in the analog signal that may occur between two samples, which can result in aliasing and may cause narrow pulses to be missed. In such cases, you should use the Peak Detect mode to acquire data.

Peak Detect: In this acquisition mode, the oscilloscope gets the maximum and minimum values of

the input signal over each sample interval and uses these values to display the waveform. In this way, the oscilloscope can acquire and display those narrow pulses that may have otherwise been missed in **Normal** mode. However, noise will appear to be higher in this mode.

Average: In this acquisition mode, the oscilloscope acquires several waveforms, averages them, and displays the resulting waveform. You can use this mode to reduce random noise.

Equivalent Acquisition: This kind of acquisition can be utilized for periodic signals. In case the acquisition rate is too low when using the real-time acquisition, the oscilloscope will use a fixed rate to acquire data with a stationary tiny delay after each acquisition of a frame of data. After repeating this acquisition for N times, the oscilloscope will arrange the acquired N frames of data by time to make up a new frame of data. Then the waveform can be recovered. The number of times N is related to the equivalent acquisition rate.

Time Base: The oscilloscope digitizes waveforms by acquiring the value of an input signal at discrete points. The time base helps to control how often the values are digitized. Use the TIME/DIV button to adjust the time base to a horizontal scale that suits your purpose.

4.4 Waveform Scaling and Positioning

The display of waveforms on the screen can be changed by adjusting their scale and position. Once the scale changes, the waveform display will increase or decrease in size. Once the position changes, the waveform will move up, down, right, or left.

The channel reference indicator (located on the left of the graticule) identifies each waveform on the screen. It points to the ground level of the waveform record.

Vertical Scale and Position: The vertical position of a waveform can be changed by moving it up and down on the screen. To compare data, you may align a waveform over another. When you push the VOLTS button to change the vertical scale of a waveform, the waveform display will contract or expand vertically to the ground level.

Horizontal Scale and Position: Pretrigger Information

You can adjust the HORIZONTAL POSITION control to view waveform data before the trigger, after the trigger, or some of each. When you change the horizontal position of a waveform, you are actually changing the time between the trigger position and the screen center.

For example, if you want to find out the cause of a glitch in your test circuit, you should trigger on the glitch and make the pretrigger period long enough to capture data before the glitch. Then you can analyze the pretrigger data and perhaps find the cause. You are allowed to change the horizontal scale of all the waveforms by clicking the TIME/DIV button. For example, you may want to see just one cycle of a waveform to measure the overshoot on its rising edge. The oscilloscope shows the horizontal scale as time per division in the scale readout. Since all active waveforms use the same time base, the oscilloscope only displays one value for all the active channels.

4.5 Waveform Measurement

The oscilloscope displays graphs of voltage versus time and can help to measure the displayed waveform. There are several ways to take measurements, using the graticule, the cursors or performing an automatic measurement.

Graticule: This method allows you to make a quick, visual estimate and take a simple measurement through the graticule divisions and the scale factor.

For example, you can take simple measurements by counting the major and minor graticule divisions involved and multiplying by the scale factor. If you counted 6 major vertical graticule divisions between the minimum and maximum values of a waveform and knew you had a scale factor of 50mV/division, you could easily calculate your peak-to-peak voltage as follows:

$$6 \text{ divisions} \times 50\text{mV/division} = 300\text{mV}.$$

Cursor: This method allows you to take measurements by moving the cursors. Cursors always appear in pairs and the displayed readouts are just their measured values. There are two kinds of cursors: Amplitude Cursor and Time Cursor. The amplitude cursor appear as a horizontal broken line, measuring the vertical parameters. The time cursor appear as a vertical broken line, measuring the horizontal parameters.

When using cursors, please make sure to set the Source to the waveform that you want to measure on the screen. To use cursors, push the CURSOR button.

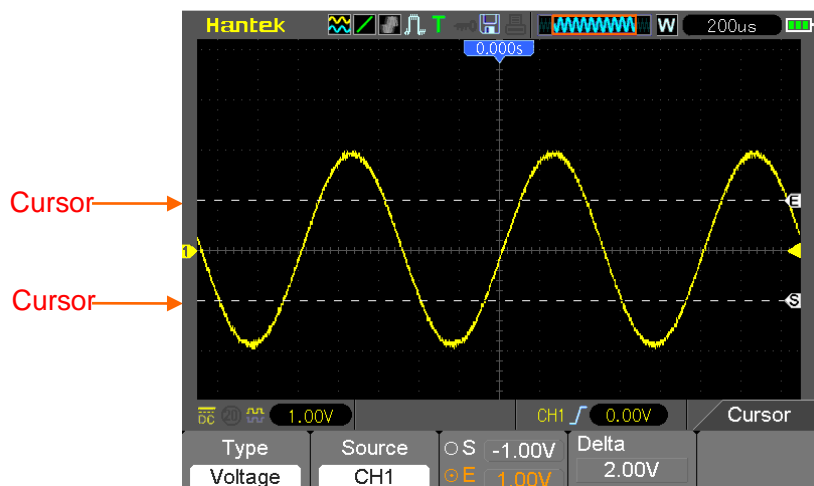

Automatic Measurement: The oscilloscope performs all the calculations automatically in this mode. As this measurement uses the waveform record points, it is more precise than the graticule and cursor measurements. Automatic measurements show the measurement results by readouts which are periodically updated with the new data acquired by the oscilloscope.

Chapter 5 Basic Operation

The front panel of the oscilloscope is divided into several functional areas. In this chapter we will give a quick overview of all control buttons on the front panel as well as the displayed information on the screen and relative testing operations. The figure below illustrates the front panel of the DSO8000E series digital oscilloscope.



Front Panel of DSO8000E Series

Description

1. LCD Display
2. F1~F5: Sets or switch options for the menu
3. Power light.
4. MEAS: Shows Measurement menu

5. AUTORANGE:
6. MENU OFF: Turn on/off the menu
7. MENU: Turn on/off the menu
8. AUTO: Be used for auto setting under the oscilloscope operation mode
9. RUN/STOP: key for running or stopping the operation
10. Direction Keys
11. TRIG: Shows Trigger menu
12. LEVEL: Adjust the trigger level
13. TIME/DIV: Decrease or Increase the time base
14. POSITION: Adjust the horizontal trigger position
15. HORI: Shows Horizontal menu
16. VERTICAL: Adjust the signal vertical position
17. VOLTS: Decrease or Increase the voltage/div
18. Power key.
19. REF: Shows the REF menu
20. MATH: Shows the Math or REF menu
21. CH2: Shows the CH2 menu
22. CH1: Shows the CH1 menu
23. UTILITY: Shows Utility menu
24. SAVE RECALL: Shows SAVE or RECALL menu
25. RECORDER:
26. SCOPE/DMM: Switch DMM, Scope function or Waveform Generator function interface.
27. CURSOR: Shows Cursor menu

5.1 DisplayArea

1. Hantek logo
2. Display Format:



: YT



: XY



: Vectors



: Dots



: Gray indicates auto persistence; Green means persistence display is enabled. When the icon is set to green, the time for persistence display will be shown behind it.

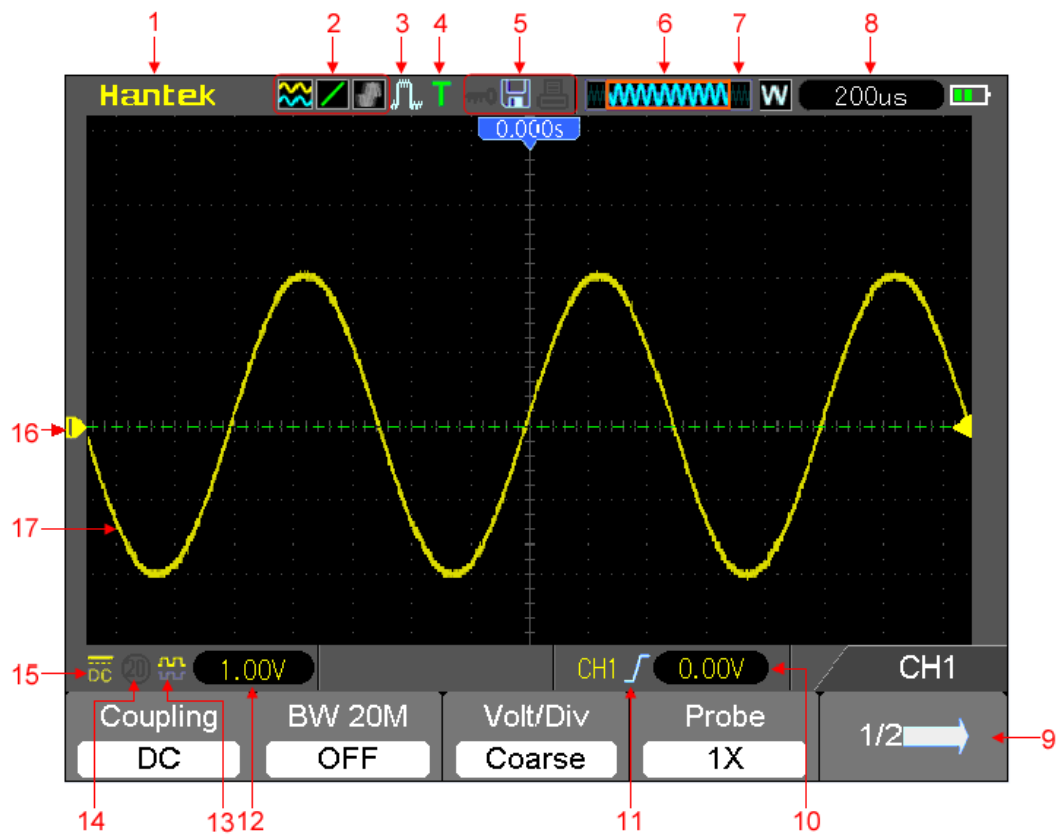



3. Acquisition Mode: Normal, Peak Detect or Average

4. Trigger Status:

- a** The oscilloscope is acquiring pretriggered data.
- R** All pretriggered data have been acquired and the oscilloscope is ready to accept a trigger.
- T** The oscilloscope has detected a trigger and is acquiring the posttrigger information.
- A** The oscilloscope works in auto mode and is acquiring waveforms in the absence of triggers.
- S** The oscilloscope is acquiring and displaying waveform data continuously in scan mode.
 - The oscilloscope has stopped acquiring waveform data.
- S** The oscilloscope has finished a single sequence acquisition.

5. Tool Icon:







: If this icon lights up, it means the keyboard of the oscilloscope is locked by the host computer via USB control.

: If this icon lights up, it means the USB disk has been connected.

: This icon lights up only when the USB slave interface is connected with the computer.

6. Main Time Base Window

7. Display of window's position in data memory and data length.

8. Window Time Base
9. Operating Menu shows different information for different function keys.
10. Trig Level.
11. Trigger Type:
 -  : Edge trigger on the rising edge.
 -  : Edge trigger on the falling edge.
 -  : Video trigger with line synchronization.
 -  : Video trigger with field synchronization.
 -  : Pulse Width trigger, positive polarity.
 -  : Pulse Width trigger, negative polarity.
12. Level Range.
13. Icon indicates whether the waveform is inverted or not.
14. 20M Bandwidth Limit. If this icon lights up, it means the bandwidth limit is enabled, otherwise disabled.
15. Icon indicates channel coupling.
16. Channel Marker
17. Window displays waveform.

5.1.1 XY Format

The XY format is used to analyze phase differences, such as those represented by Lissajous patterns. The format plots the voltage on CH1 against the voltage on CH2, where CH1 is the horizontal axis and CH2 is the vertical axis. The oscilloscope uses the untriggered Normal acquisition mode and displays data as dots. The sampling rate is fixed at 1 MS/s.

The oscilloscope can acquire waveforms in YT format at any sampling rate. You may view the same waveform in XY format. To perform this operation, stop the acquisition and change the display format to XY.

The table below shows how to operate some controls in XY format.

Controls	Usable or not in XY format
CH1 VOLTS and VERTICAL POSITION controls	Set the horizontal scale and position
CH2 VOLTS and VERTICAL POSITION controls	Continuously set the vertical scale and position
Reference or Math	Unusable
Cursors	Unusable
Autoset (display format reset to YT)	Unusable
Time base controls	Unusable
Trigger controls	Unusable

5.2 Horizontal Controls

Use the horizontal controls to change the horizontal scale and position of waveforms. The horizontal position readout shows the time represented by the center of the screen, using the trigger time as zero. When you change the horizontal scale, the waveform will expand or contract to the screen center. The readout near the upper right of the screen shows the current horizontal position in second. M represents 'Main Time Base', and W indicates 'Window Time Base'. The oscilloscope also has an arrow icon at the top of the graticule to indicate the horizontal position.



- HORIZONTAL POSITION BAR:** Used to control the trigger position against the screen center.
- Each option in **HORI MENU** is described as follows.

Options	Settings	Comments
Window Ctrl	Double Win Single Win	Set the Current window mode to single or double window.
Window Sel	Major Win Minor Win	Selects the major or minor window in dual-window mode. The window is highlighted once selected. Press this option button in single-window mode to enter the dual-window mode.
HoldOff		Select this menu and click the up and down Arrow keys to adjust the trigger holdoff time within the range of 100ns-10s.
Reset		Recover the horizontal trigger position to the middle screen.
Pre Mark		This function is usable only in dual-window mode. It sets marks at some waveform record locations that users are interested in, and searches for these marks by right and left arrows. Then it positions the window to this mark for further observation.
Next Mark		This function is usable only in dual-window mode. It sets marks at some waveform record locations that users are interested in, and searches for these marks by right and left arrows. Then it positions the window to this mark for further observation.
Set/Clear		Set or Clear the current Mark.

Play/Stop

This function is usable in dual-window mode. Push this menu button and auto move it from left to right at a specified speed. In the expanded window will display corresponding waveforms until it stops once reaching the rightmost side of the major scan window.

Single-window Mode

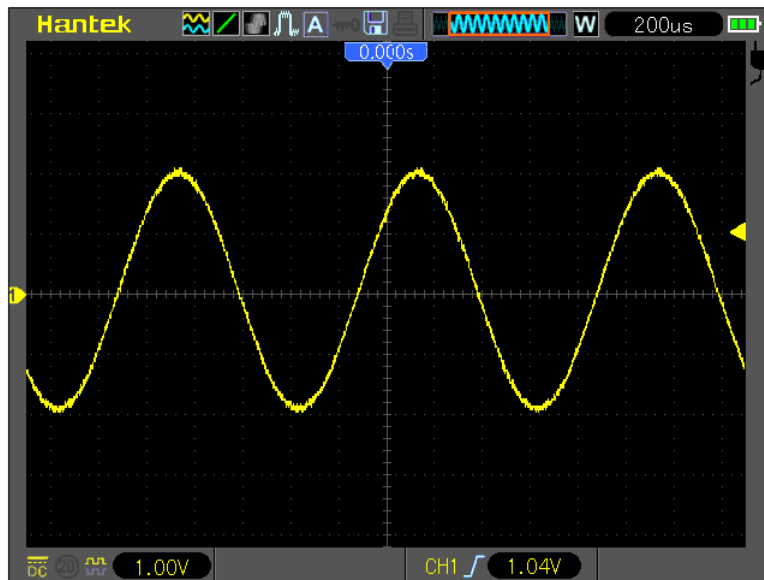

Dual-window Mode (Full Screen)

Location of expanded window data in memory

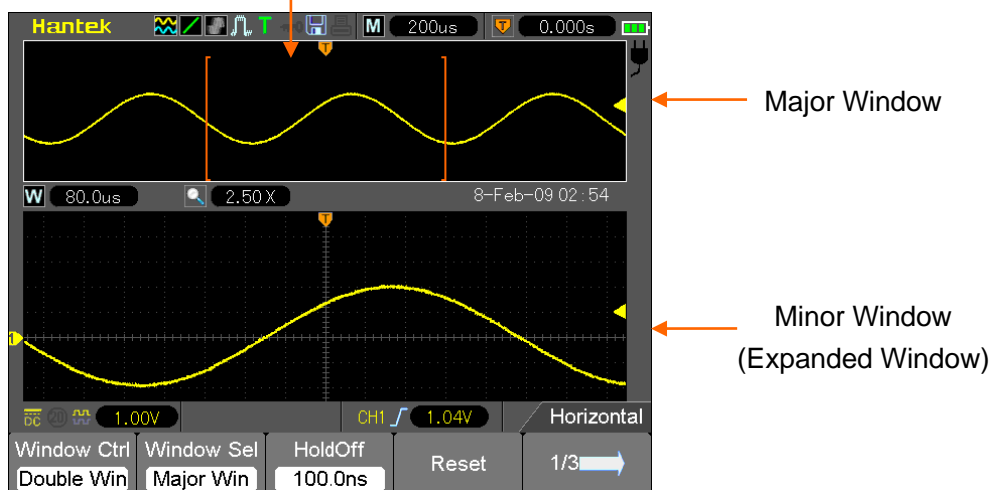

3.TIME/DIV: Used to change the horizontal time scale so as to magnify or compress the waveform horizontally. If the waveform acquisition is stopped (by using the RUN/STOP button), the TIME /DIV control will expand or compress the waveform. In dual-window mode, push button F1 to select major or minor window. When the major window is selected, the F1 button provides the same functions as it provides in single-mode window. When the minor window is selected, press TIME/DIV button to scale the waveform whose magnification is up to 1000.

5.2.1 Scan Mode Display (Roll Mode)

With the TIME/DIV control set to 80ms/div or slower and the trigger mode set to Auto, the oscilloscope works in the scan acquisition mode. In this mode, the waveform display is updated from left to right without any trigger or horizontal position control.

5.3 Vertical Controls

Vertical controls can be used to display and remove waveforms, adjust vertical scale and position, set input parameters and perform math calculations. Each channel has a separate vertical menu to set. See below for menu description.

1. **VERTICAL POSITION Bar:** Move the channel waveform up and down on the screen. In dual-window mode, move the waveforms in both windows at the same time in a same direction. Two channels correspond to two bars.

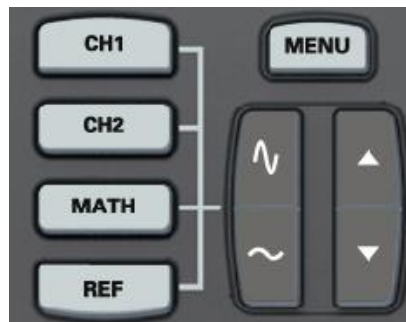

2. **Menu (CH1, CH2):** Display vertical menu options; turn on or off the display of channel waveforms.

Options	Settings	Comments
Coupling	DC AC GND	DC passes both DC and AC components of the input signal. AC blocks the DC component of the input signal and attenuates signals below 10Hz. Ground disconnects the input signal.
20MHz Bandwidth Limit	Unlimited Limited	Limits the bandwidth to reduce display noise; filters the signal to eliminate noise and other unnecessary HF components.
Volt/Div	Coarse Fine	Selects the resolution of the VOLTS bar. Coarse defines a 1-2-5 sequence. Fine changes the resolution to small steps between the Coarse settings.
Probe	1X 10X 100X 1000X	Selects a value according to the probe attenuation factor so as to ensure correct vertical readouts. Reduce bandwidth to 6MHz when using a 1X probe.
Invert	Off On	Inverts the waveform relative to the reference level.
Reset		Set the channel vertical position to the middle of the vertical screen,

Ground Coupling

Used to display a zero-volt waveform. Internally, the channel input is connected with a zero-volt reference level.

Fine Resolution

In the fine resolution setting, the vertical scale readout displays the actual VOLTS setting. The vertical scale changes only after you adjust the VOLTS control and set to coarse.

Remove Waveform Display

To remove a waveform from the screen, first push the menu button to display the vertical menu, then push again to remove the waveform. A channel waveform which is unnecessary to be displayed can be used as a trigger source or for math operations.

3. VOLTS

Control the oscilloscope to magnify or attenuate the source signal of the channel waveform. The vertical size of the display on the screen will change (increase or decrease) to the ground level. Also you may use the key F3 to switch between coarse and fine.

4. **MATH MENU:** Display the waveform math operations. See the table below for details.

The MATH menu contains source options for all math operations.

Operations	Source Options	Comments
+	CH1+CH2	Add Channel 1 to Channel 2.
-	CH1-CH2	Subtract the Channel 2 waveform from the Channel 1 waveform.
	CH2-CH1	Subtract the Channel 1 waveform from the Channel 2 waveform.
X	CH1XCH2	Multiply CH1 with CH2.
/	CH1/CH2	CH1 Dvided by CH2
	CH2/CH1	CH2 Dvided by CH1
Position		Set the Math channel's position.
Scale		Set the Vertical Scale.
FFT	Window	Five types of window available for selection: Hanning, Flattop, Rectangular, Bartletta and Blackman
	Source	CH1 CH2
	FFT zoom	Use the FFT Zoom button to adjust the window size. Scale: x1, x2, x5, x10.
	Vertical Base	dBrms Vrms

Note: All selected menus are highlighted in orange.

5.3.1 Math FFT

This chapter elaborates how to use the Math FFT (Fast Fourier Transform). You can use the Math FFT mode to convert a time-domain (YT) signal into its frequency components (spectrum), and to observe the following types of signals:

- Analyze harmonics in power cords;
- Measure harmonic content and distortion in systems;
- Characterize noise in DC power supplies;
- Test impulse response of filters and systems;
- Analyze vibration.

To use the Math FFT mode, perform the following tasks:

- Set the source (time-domain) waveform;
- Display the FFT spectrum;
- Choose a type of FFT window;
- Adjust the sample rate to display the fundamental frequency and harmonics without aliasing;
- Use zoom controls to magnify the spectrum;
- Use cursors to measure the spectrum.

5.3.1.1 Setting Time-domain Waveform

It is necessary to set the time-domain (YT) waveform before using the FFT mode. Follow the steps below.

1. Push the AUTO button to display a YT waveform.
2. Click the Vertical Position key to vertically move the YT waveform to the center (zero division) so as to ensure the FFT will display a true DC value.
3. Click the Horizontal Position key to position the part of the YT waveform to be analyzed in the center eight divisions of the screen. The oscilloscope uses the 2048 center points of the time-domain waveform to calculate the FFT spectrum.
4. Click the VOLTS Key to ensure the entire waveform remains on the screen. If the entire waveform is invisible, the oscilloscope may display wrong FFT results by adding high-frequency components.
5. Click the TIME/DIV key to provide the resolution you need in the FFT spectrum.
6. If possible, set the oscilloscope to display multiple signal cycles.

If you Click the TIME/DIV key to select a faster setting (fewer cycles), the FFT spectrum will display a larger frequency range and reduce the possibility of FFT aliasing.

To set the FFT display, follow the steps below.

1. Push the M/R button;

2. Set the Operation option to FFT;
3. Select the Math FFT Source channel.

In many situations, the oscilloscope can also generate a useful FFT spectrum despite the YT waveform not being triggered. This is especially true if the signal is periodic or random (such as noise).

Note: *You should trigger and position transient or burst waveforms as close as possible to the screen center.*

Nyquist Frequency

The highest frequency that any real-time digital oscilloscope can measure without errors is half of the sample rate, which is called the Nyquist frequency. Frequency information beyond the Nyquist frequency is undersampled which brings about the FFT aliasing. The math function can convert the center 2048 points of the time-domain waveform to an FFT spectrum. The resulting FFT spectrum contains 1024 points from DC (0Hz) to the Nyquist frequency. Usually, the screen compresses the FFT spectrum horizontally to 250 points, but you can use the FFT Zoom function to expand the FFT spectrum so that you can clearly view the frequency components at each of the 1024 data points in the FFT spectrum.

Note: *The oscilloscope's vertical response is a little bit larger than its bandwidth (70MHz, 100MHz, 150MHz or 200MHz, depending on the model; or 20MHz when the Bandwidth Limit option is set to Limited). Therefore, the FFT spectrum can display valid frequency information above the oscilloscope bandwidth. However, the amplitude information near or above the bandwidth will not be accurate.*

5.3.1.2 Displaying FFT Spectrum

Push the MATH MENU button to display the Math menu. Use the options to select the Source channel, the Window algorithm and the FFT Zoom factor. Only one FFT spectrum can be displayed at a time.

Math FFT Options	Settings	Comments
Source	CH1, CH2	Choose a channel to be the FFT source.
Window	Hanning, Flattop, Rectangular, Bartlett, Blackman	Select a type of the FFT window. For more information, refer to Section 5.3.1.3 .
FFT Zoom	X1, X2, X5, X10	Change the horizontal magnification of the FFT display. For detailed information, refer to Section 5.3.1.6 .
Vertical Base	dBrms, Vrms	Set dBrms to be the vertical base; Set Vrms to be the vertical base

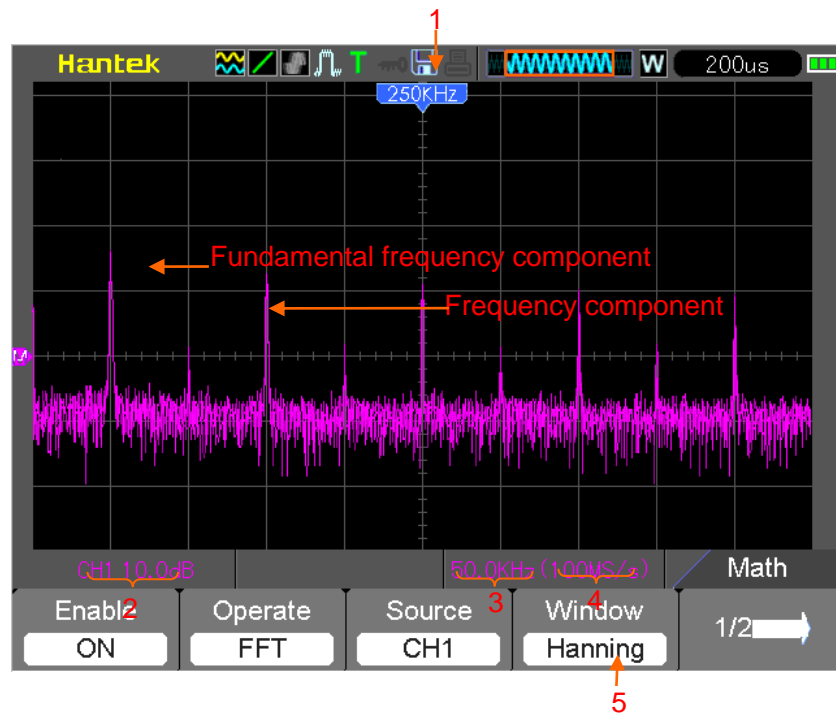

1. Frequency at the center graticule line
2. Vertical scale in dB per division (0dB=1V_{RMS})
3. Horizontal scale in frequency per division
4. Sample rate in number of samples per second
5. FFT window type

5.3.1.3 Selecting FFT Window

Using windows can eliminate the spectral leakage in the FFT spectrum. The FFT algorithm assumes that the YT waveform repeats all the time. When the number of cycles is integral (1, 2, 3 ...), the YT waveform starts and ends at the same amplitude and there are no discontinuities in the signal shape.

If the number of cycles is nonintegral, the YT waveform starts and ends at different amplitudes and transitions between the start and end points will cause discontinuities in the signal that introduces high-frequency transients.

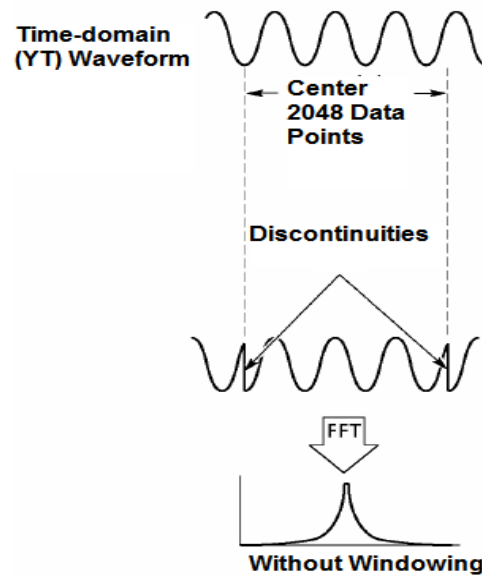

Applying a window to the YT waveform changes the waveform so that the start and stop values are close to each other, which reduces the discontinuities.

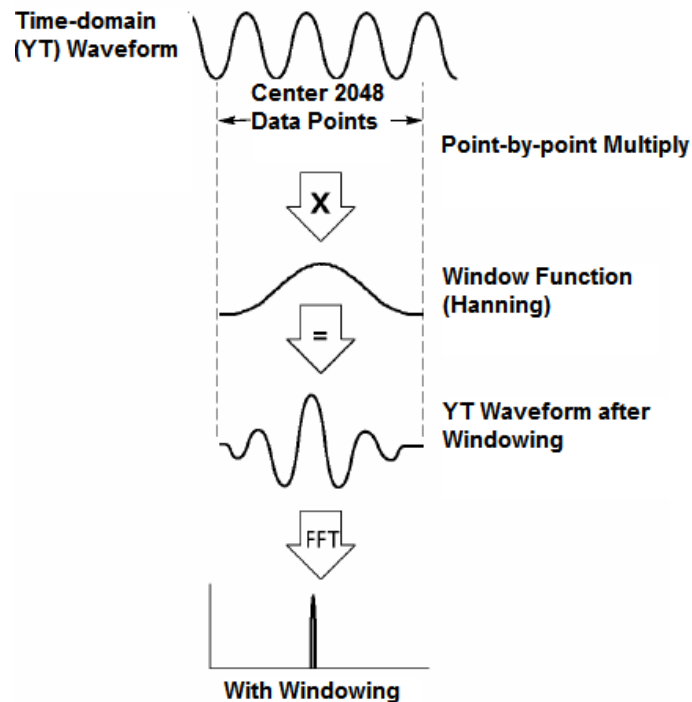

The Math FFT function has three FFT Window options. There is a trade-off between frequency resolution and amplitude accuracy for each type of window. You shall determine which one to choose according to the object you want to measure and the source signal characteristics.

Window	Measurement	Characteristics
Hanning	Periodic Waveform	Better frequency, poorer amplitude accuracy than Flattop
Flattop	Periodic Waveform	Better amplitude, poorer frequency accuracy than Hanning
Rectangular	Pulse or Transient Waveform	Special-purpose window applicable to discontinuous waveforms. This is actually the same as no windows.

Bartlett		
Blackman	Best magnitude, worst frequency resolution.	Single frequency waveforms, to Find higher order harmonics.

5.3.1.4 FFT Aliasing

Problems occur when the time-domain waveform acquired by the oscilloscope contains frequency components higher than the Nyquist frequency. The frequency components above the Nyquist frequency will be undersampled and displayed as lower frequency components that 'fold back' from the Nyquist frequency. These erroneous components are called aliases.

5.3.1.5 Eliminating Aliases

To eliminate aliases, use the following methods.

- Click the TIME/DIV key to set a faster sample rate. Because the Nyquist frequency increases as you increase the sample rate, the aliased frequency components will be displayed correct. If too many frequency components appear on the screen, you may use the FFT Zoom option to magnify the FFT spectrum.
- If there is no need to observe the frequency components above 20MHz, set the Bandwidth Limit option to Limited.
- Filter the signal input from outside and limit the bandwidth of the source waveform to lower than the Nyquist frequency.
- Identify and ignore the aliased frequencies.
- Use zoom controls and cursors to magnify and measure the FFT spectrum.

5.3.1.6 Magnifying and Positioning FFT Spectrum

You may scale the FFT spectrum and use cursors to measure it through the FFT Zoom option which enables the horizontal magnification. To vertically magnify the spectrum, use the vertical controls.

Horizontal Zoom and Position

You can use the FFT Zoom option to magnify the FFT spectrum horizontally without changing the sample rate. The available zoom factors are X1(default), X2, X5 and X10. When the zoom factor is set to X1 and the waveform is located at the center graticule, the left graticule line is at 0Hz and the right is at the Nyquist frequency.

You magnifies the FFT spectrum to the center graticule line when you change the zoom factor. That is, the axis for horizontal magnification is the center graticule line. Click the Horizontal Position Key to move the FFT spectrum to the right.

Vertical Zoom and Position

When the FFT spectrum is being displayed, the channel vertical keys become the zoom and position controls corresponding to their respective channels. The VOLTS key provides the following zoom factors: X1(default), X2, X5 and X10. The FFT spectrum is magnified vertically to the marker M (math waveform reference point on the left edge of the screen). Click the **Vertical Position** key to move up the spectrum.

5.3.1.7 Using Cursors to Measure FFT Spectrum

You may use cursors to take two measurements on the FFT spectrum: amplitude (in dB) and frequency (in Hz). Amplitude is referenced to 0db that equals 1VRMS here. You may use cursors to measure at any zoom factor.

Push the CURSOR button, choose the Source option and then select Math. Press the Type option button to select between Amplitude and Frequency. Click the SELECT CURSOR option to choose a cursor. Then move Cursor S and Cursor E. Use the horizontal cursor to measure the amplitude and the vertical cursor to measure the frequency. Now the display at the DELTA menu is just the measured value, and the values at Cursor S and Cursor E.

Delta is the absolute value of Cursor S minus Cursor E.

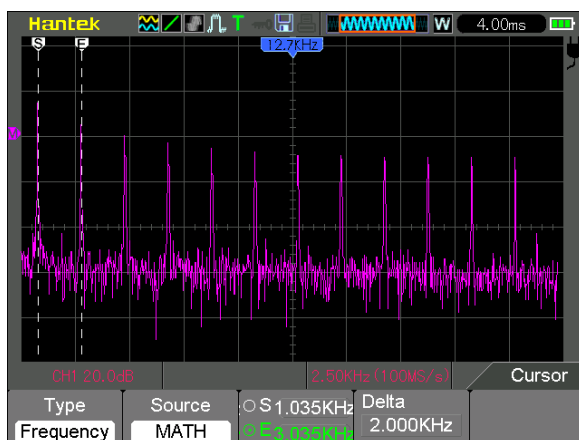

Frequency Cursors

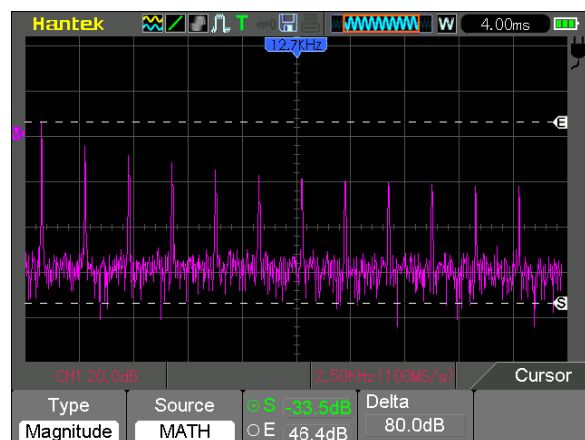

Amplitude Cursors

5.4 Trigger Controls

The trigger can be defined through the Trigger Menu. There are six types of trigger: Edge, Video, Pulse Width, Alter, Slope and Overtime. Refer to the following tables to find a different set of options for each type of trigger.

TRIG MENU

Push this button to display trigger menus. The edge trigger is in common use. See the table below for details.

TRIG Level

It sets the amplitude level the signal must cross to cause an acquisition when using the Edge or Pulse Width trigger.

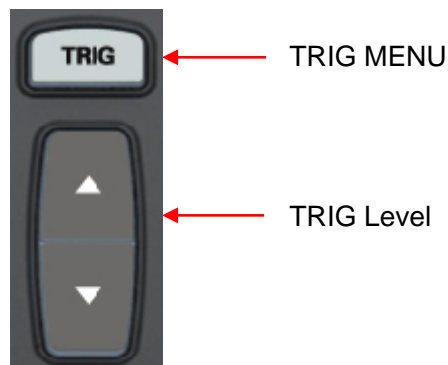

Options	Settings	Comments
Trigger Type		
Edge		By default the oscilloscope uses the edge trigger which triggers the oscilloscope on the rising or falling edge of the input signal when it crosses the trigger level (threshold).
Source	CH1 CH2 EXT/5	Select the input source as the trigger signal. CH1, CH2: No matter the waveform is displayed or not, a certain channel will be triggered. EXT/5: Same as EXT option, but attenuates the signal by a factor of 5 and allows a trigger level range of +6V to -6V.
Mode	Auto Normal Single	Select a trigger mode. By default, the oscilloscope uses the Auto mode. In this mode, the oscilloscope is forced to trigger when it does not detect a trigger within a certain amount of time based on the TIME/DIV setting. The oscilloscope goes into the scan mode at 80ms/div or slower time base settings. In the Normal mode, the oscilloscope updates the display only when it detects a valid trigger condition. New waveforms are not displayed until they replace old ones. Use this mode to just view valid triggered waveforms. Only after the first trigger does the display appear.
Coupling	AC DC Noise Reject HF Reject LF Reject	Select the components of the trigger signal applied to the trigger circuitry. AC: Blocks DC components and attenuates signals below 10Hz. DC: Passes all components of the signal. Noise Reject: Attenuates the noise components. HF Reject: Attenuates the high-frequency components above 80kHz. LF Reject: Blocks DC components and attenuates the low-frequency components below 8kHz.
50%		Set the vertical trigger position to the channel zero level position.

NOTE: Trigger coupling only affects the signal passed through the trigger system. It does not affect the bandwidth or coupling of the signal displayed on the screen.

Video Trigger

Options	Settings	Comments
Video		With Video highlighted, an NTSC, PAL or SECAM standard video signal will be triggered. The trigger coupling is preset to AC.
Source	CH1 CH2 EXT/5	Select the input source as the trigger signal. Ext/5 use the signal applied to the EXT TRIG connector as the source.
Polarity	Normal Inverted	Normal: Triggers on the negative edge of the sync pulse. Inverted: Triggers on the positive edge of the sync pulse.
Sync	All Lines Line Number Odd Field Even Field All Fields	Choose a proper video sync. When selecting Line Number for the Sync option, you may use the User Select it to specify a line number.
Standard	NTSC PAL/SECAM	Choose a video standard for sync and line number count.

Note: When you choose Normal Polarity, the trigger always occurs on negative-going sync pulses. If the video signal contains positive-going sync pulses, use the Inverted Polarity option.

Pulse Width Trigger

You can use it to trigger on aberrant pulses.

Options	Settings	Comments
Pulse		With Pulse highlighted, the trigger occurs on pulses that meet the trigger condition (defined by the Source, When and Set Pulse Width options).
Source	CH1 CH2 EXT/5	Select the input source as the trigger signal. EXT/5: Does not display the trigger signal and allows a trigger level range of +6V to -6V.
Polarity	Positive, Negative	
Mode	Auto Normal Single	Select the type of trigger. The Normal mode is best for most pulse width trigger applications.
Coupling	AC DC Noise Reject HF Reject LF Reject	Select the components of the trigger signal applied to the trigger circuit.
When	= ≠ < >	Select the trigger condition.
Pulse Width	20ns to 10.0sec 50%	With Set Pulse Width highlighted, set the pulse width.

Trigger When: The pulse width of the source must be $\geq 5\text{ns}$ so that the oscilloscope can detect the pulse.

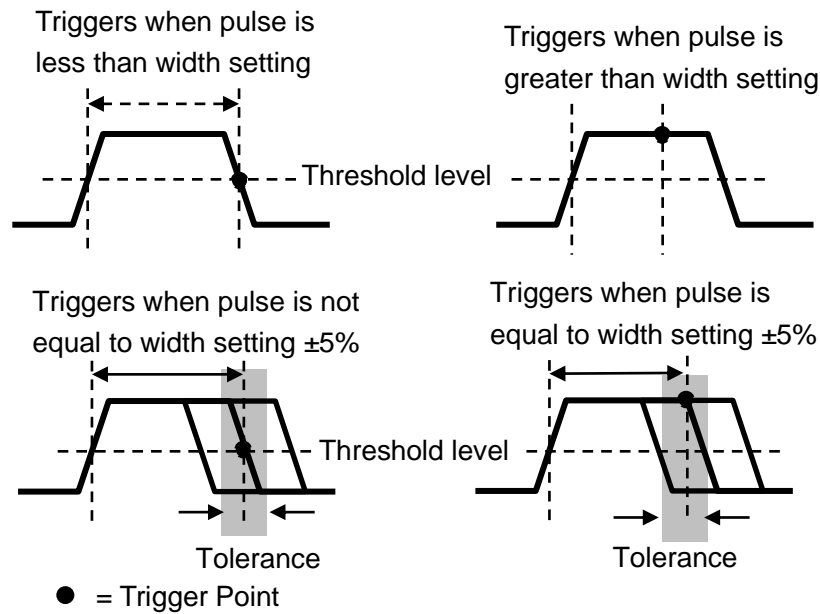

=, ≠: Within a $\pm 5\%$ tolerance, triggers the oscilloscope when the signal pulse width is equal to or not equal to the specified pulse width.

<, >: Triggers the oscilloscope when the source signal pulse width is less than or greater than the specified pulse width.

Slope Trigger: Judges trigger according to the time for rising or falling, more flexible and accurate than the Edge trigger.

Options	Settings	Comments
Slope		
Source	CH1 CH2 EXT/5	Select the input source as the trigger signal.
Slope	Rising Falling	Select the slope type of signal.
Mode	Auto Normal	Select the type of trigger. The Normal mode is best for most pulse width trigger applications.
Coupling	AC DC Noise Reject HF Reject LF Reject	Selects the components of the trigger signal applied to the trigger circuitry.
Vertical	V1 V2	Adjust the vertical window by setting two trigger levels. Select this option and press F3 to choose V1 or V2.
When	= ≠ < >	Select the trigger condition.
Time	20ns to 10.0sec	With this option highlighted, set the time span.

Alter Trigger: As a feature of analog oscilloscopes, it gives stable displays of signals at two different frequencies. Mainly it uses a specific frequency to switch between two analog channels CH1 and CH2 so that the channels will generate Alter trigger signals through the trigger circuitry.

Options	Settings	Comments
Alter		
Mode	Auto Normal	Select the type of trigger.
Channel	CH1 CH2	Push an option such as CH1, select the channel trigger type and set the menu interface.
Below list options in submenus. Alter Trigger allows CH1 and CH2 to select different trigger modes and to display waveforms on a same screen. That is both channels can choose the following four trigger modes.		
Type	Edge	
Slope	Rising Falling	
Coupling	AC DC Noise Reject HF Reject LF Reject	Select the components of the trigger signal applied to the trigger circuitry.
Type	Video	
Polarity	Normal Inverted	
Standard	NTSC PAL/SECAM	
Sync	All Lines Line Number Odd Field Even Field All Fields	Choose a proper video sync. When selecting Line Number for the Sync option, you may use the User Select it to specify a line number.
Type	Pulse	
Polarity	Positive Negative	
When	= ≠ < >	Select the trigger condition.
Set PW	Pulse Width	Set the pulse width.
Coupling	AC DC Noise Reject HF Reject LF Reject	Selects the components of the trigger signal applied to the trigger circuitry.
Type	O.T.	

Polarity	positive Negative	
Overtime	20ns to 10.0sec	Set the time span.
Coupling	AC DC Noise Reject HF Reject LF Reject	Selects the components of the trigger signal applied to the trigger circuitry.

Overtime Trigger: In Pulse Width trigger, you may sometimes be puzzled with the long time for trigger, as you do not need a complete pulse width to trigger the oscilloscope, but want the trigger occurs just upon the overtime point. This is called Overtime Trigger.

Options	Settings	Comments
Type	O.T.	
Source	CH1 CH2	Select the trigger source.
Polarity	Positive Negative	Select to trigger on positive or negative pulses.
Mode	Auto Normal	
Overtime		
Coupling	AC DC Noise Reject HF Reject LF Reject	Selects the components of the trigger signal applied to the trigger circuitry.
	50%	

Holdoff: To use Trigger Holdoff, push the HORI button and set the Holdoff Time option. The Trigger Holdoff function can be used to generate a stable display of complex waveforms (such as pulse trains). Holdoff is the time between when the oscilloscope detects one trigger and when it is ready to detect another. During the holdoff time, the oscilloscope will not trigger. For a pulse train, the holdoff time can be adjusted to let the oscilloscope trigger only on the first pulse in the train.

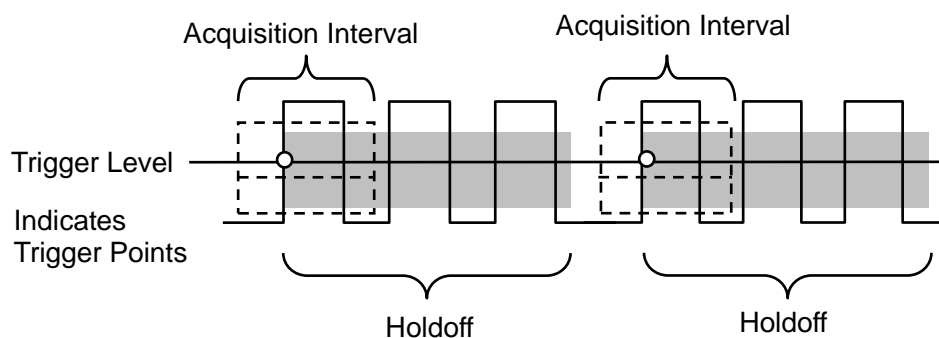

5.5 Menu and Option Buttons

As shown below, these four buttons at the front panel are used mainly to recall relative setup menus.

SAVE/RECALL: Displays the Save/Recall menu for setups and waveforms.

MEASURE: Displays the Measure menu.

UTILITY: Displays the Utility menu.

CURSOR: Displays the Cursor menu.

5.5.1 SAVE/RECALL

Press the SAVE/RECALL button to save or recall oscilloscope setups or waveforms.

Options	Settings	Comments
Wave		Enter the Save Wave menu.
Setup		Enter the S/R Setup menu.
CSV		Enter the CSV menu.
Default		Recall default setup.
Save Wave		Save the screen picture.

Options	Settings	Comments
Wave		
Source	CH1, CH2	Select a waveform display to store.
Media	USB Flash SD	Select media.
Location	0-1000	
Save		Save the source waveform to the selected reference location.
Recall		Display the reference waveform on the screen.
Delete		Delete waveform.

Options	Settings	Comments
Setup		
Source	Local USB disk	Store the current setups to the USB disk or the memory of the oscilloscope.
Location	0 to 9	Specify the memory location in which to store the current waveform settings or from which to recall the waveform settings.
Save		Complete the saving operation.
Recall		Recall the oscilloscope settings stored in the location selected in the Setup field. Push the Default Setup button to initialize the oscilloscope to a known setup.

Options	Settings	Comments
CSV		
Source	CH1 CH2	Select a waveform channel to store.
File List	Open Close	Open or Close File List.
Save		Save the source waveform to the selected location.
Recall		Display the reference waveform on the screen
Delete		Delete waveform.

5.5.2 MEASURE

Push the **MEAS** button to perform auto measurements. There are 32 types of measurements and up to 4 types can be displayed on the screen. User can turn **directions** keys to select measurement item, or push "**Modify** -> **Type**" to select the measurement type.

Press "**Modify**" button to select the measure source (CH1 or CH2) and measure type. Then press "**OK**" button to change successfully.

Click the **MEAS** key then the following menu appears.

Options	Settings	Comments
Source	CH1 CH2	Select the measure source.
Measurement Type		
1	Frequency	Calculate the waveform frequency by measuring the first cycle.
2	Period	Calculate the time of the first cycle.
3	Mean	Calculate the arithmetic mean voltage over the entire waveform.
4	Pk-Pk	Calculate the absolute difference between the greatest and the smallest peaks of the entire waveform.
5	CRMS	Calculate the Root Mean Square voltage over the entire waveform.
6	PRMS	Calculate the actual RMS measurement of the first complete cycle in the waveform.
7	Min	The most negative peak voltage measured over the entire waveform.
8	Max	The most positive peak voltage measured over the entire waveform.
9	Rising	Measure the time between 10% and 90% of the first rising edge of the waveform.
10	Falling	Measure the time between 90% and 10% of the first falling edge of the waveform.
11	+ Width	Measure the time between the first rising edge and the next falling edge at the waveform 50% level.

12	- Width	Measure the time between the first falling edge and the next rising edge at the waveform 50% level.
13	+ Duty	Measure the first cycle waveform. Positive Duty Cycle is the ratio between positive pulse width and period.
14	- Duty	Measure the first cycle waveform. Negative Duty Cycle is the ratio between positive pulse width and period.
15	Base	Measure the highest voltage over the entire waveform.
16	Top	Measure the lowest voltage over the entire waveform.
17	Middle	Measure the voltage of the 50% level from base to top.
18	Amplitude	Voltage between Vtop and Vbase of a waveform.
19	Overshoot	Defined as $(\text{Base} - \text{Min})/\text{Amp} \times 100 \%$, Measured over the entire waveform.
20	Preshoot	Defined as $(\text{Max} - \text{Top})/\text{Amp} \times 100 \%$, Measured over the entire waveform.
21	PMean	Calculate the arithmetic mean voltage over the first cycle in the waveform.
22	FOVShoot	Defined as $(\text{Vmin} - \text{Vlow})/\text{Vamp}$ after the waveform falling.
23	RPREShoot	Defined as $(\text{Vmin} - \text{Vlow})/\text{Vamp}$ before the waveform falling.
24	BWidth	The duration of a burst measured over the entire waveform.
25	Delay 1-2 ↑	The time between the first rising edge of source 1 and the first rising edge of source 2.
26	Delay 1-2 ↓	The time between the first falling edge of source 1 and the first falling edge of source 2.
27	LFF	The time between the first falling edge of source 1 and the last falling edge of source 2.
28	LFR	The time between the first falling edge of source 1 and the last rising edge of source 2.
29	LRF	The time between the first rising edge of source 1 and the last falling edge of source 2.
30	LRR	The time between the first rising edge of source 1 and the last rising edge of source 2.
31	FFR	The time between the first falling edge of source 1 and the first rising edge of source 2.
32	FRF	The time between the first rising edge of source 1 and the first falling edge of source 2.
	Off	Do not take any measurement.

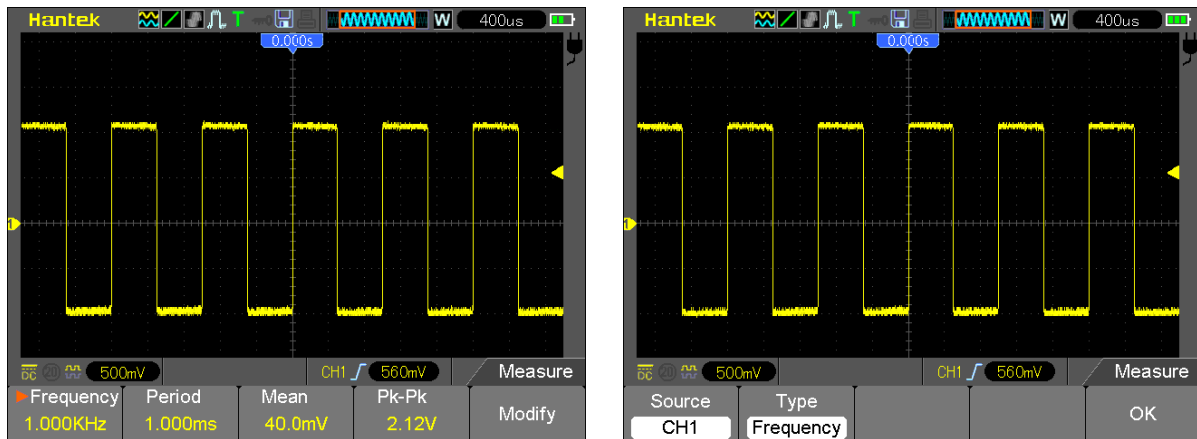

The readouts in big font size on the menu are just results of the corresponding measurements.

Taking Measurements: For a single waveform (or a waveform divided among multiple waveforms), up to 4 automatic measurements can be displayed at a time. The waveform channel must stay in an 'ON' (displayed) state to facilitate the measurement. The automatic measurement can not be performed on reference or math waveforms, or in XY or Scan mode.

5.5.3 UTILITY

Push the UTILITY key to display the Utility Menu as follows.

Options	Comments
System Info	Display the software and hardware versions, serial number and some other information about the oscilloscope.
Update	Insert a USB disk with upgrade program and the disk icon at the top left corner is highlighted. Press the Update Program button and the Software Upgrade dialog pops up.
Self Cal	Press this option and the Self Calibration dialog pops up. Press F6 to perform the self calibration.
System	Turn on/off sound, Change Language and interface, and Time Set
Shutdown	Set Action and Time
Probe Ck	Refer to 3.3.2
Pass/Fail	Pass/ Fail test
Record	Record and play back.
Filter	Set Filter function.
Display	Refer to 5.5.6
Acquire	Refer to 5.5.3
DMM	Tun on/off DMM fuction.
Frequency	Turn on/off frequency counter
More..	Sys Status, System Features, Flash and Waveform Color.

Self Cal: The self calibration routine can optimize the precision of the oscilloscope to fit the ambient temperature. To maximize the precision, you should perform the self calibration once the ambient temperature changes by 5°C or more. Follow the instructions on the screen.

Tip: Press any menu button on the front panel to remove the status display and enter a corresponding menu.

5.5.4 DISPLAY

The waveform display is affected by settings of the oscilloscope. A waveform can be measured once it is captured. The different styles to display a waveform on the screen give significant information about it.

There are two modes to display waveforms Single-window and Dual-window. Refer to Horizontal Controls for more information.

The DISPLAY menu.

Options	Settings	Comments
Type	Vectors Dots	Vectors fills up the space between adjacent sample points in the display; Dots only displays the sample points.
Persistency	OFF 0.2S-8S selectable Infinite	Sets the time length to display each displayed sample point.
DSO Mode	YT XY	YT format shows the vertical voltage in relation to time (horizontal scale); XY format displays a dot between CH1 and CH2 each time when a sample is acquired, where the voltage or current of CH1 determines the X coordinate of the dot (horizontal) and the voltage or current of CH2 determines the Y coordinate (vertical). For detailed information, refer to descriptions on XY format in the following text.
Contrast		0-15 16 ranks adjustable.
Grid	Dotted line Real line OFF	Off only displays the horizontal and vertical coordinates at the center graticule on the screen.
Grid Intensity		0-15 16 ranks adjustable.
Refresh Rate	Auto 50 Frames 40 Frames 30 Frames	
Wave Bright		0-15 16 ranks adjustable.
BL Keep	5s,10,30s,60s,Unlimited	
Menu Keep	5s,10,30s,60s,Unlimited	

5.5.5 ACQUIRE

Press “UTILITY” key to enter the Utility menu and turn to the page 4/5 and then Push the ACQUIRE key to set the acquisition parameter.

Options	Settings	Comments
Type	Real Time Equ-Time	Acquire waveforms by real-time digital technique. Rebuild waveforms by equivalent sample technique.
Mode (Real Time)	Normal Peak Detect Average	Acquire and accurately display most waveforms. Detect glitches and eliminate the possibility of aliasing. Reduce random or uncorrelated noise in signal display. The number of averages is selectable.
Averages (Real Time)	4, 8, 16, 32, 64, 128	Select the number of averages.
LongMem (Real Time)	4K, 40K, 512K, 1M, 2M	Select the memory depth for different board models.

Normal: For the oscilloscope model with the bandwidth of 100MHz, the maximum sample rate is 1GS/s. For time base with insufficient sample rate, you may use the Sine Interpolation Algorithm to interpolate points between sampled points to produce a complete waveform record (4K by default).

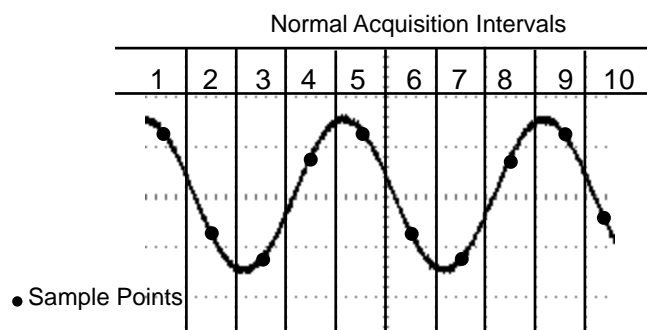

Normal Mode Acquires a Single Sample Point in Each Interval

Peak Detect: Use this mode to detect glitches within 10ns and to limit the possibility of aliasing. This mode is valid at the TIME/DIV setting of 4 μ s/div or slower. Once you set the TIME/DIV setting to 4 μ s/div or faster, the acquisition mode will change to Normal because the sample rate is fast enough that Peak Detect is unnecessary. The oscilloscope does not display a message to tell you that the mode has been changed to Normal.

Average: Use this mode to reduce random or uncorrelated noise in the signal to be displayed. Acquire data in Normal mode and then average a great number of waveforms. Choose the number of acquisitions (4, 16, 64 or 128) to average for the waveform.

Stopping the Acquisition: When you are running the acquisition, the waveform display is live. Stop the acquisition (press the RUN/STOP button) to freeze the display. In either mode, the

waveform display can be scaled or positioned by vertical and horizontal controls.

Equivalent Acquisition: Just repeat the Normal acquisition. Use this mode to take a specific observation on repeatedly displayed periodic signals. You can get a resolution of 40ps, i.e. 25GSa/s sample rate, which is much higher than that obtained in real-time acquisition.

The acquisition principle is as follows.

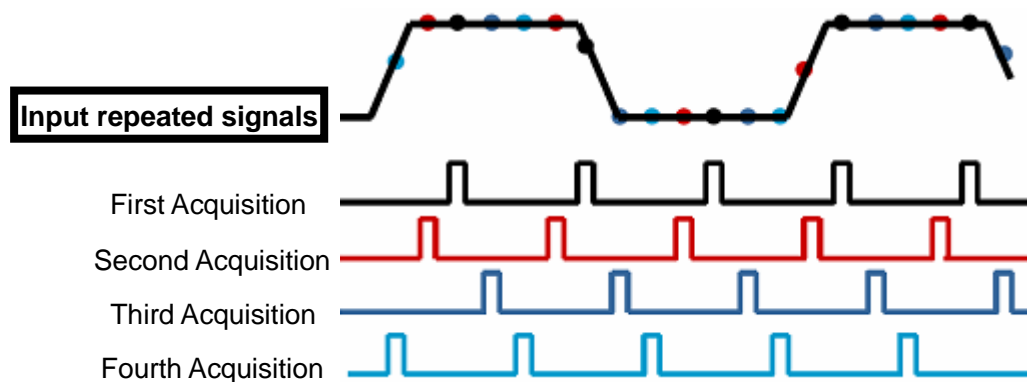

As shown above, acquire input signals (cycle repeatable) for more than once at a slow sample rate, arrange the sample points by the time they appear, then recover waveforms.

5.5.6 CURSOR

The Cursor Menu.

Options	Settings	Comments
Type	Off Voltage Time	Select a measurement cursor and display it. Voltage measures amplitude while Time measures time and frequency.
Source	CH1 CH2 MATH REFA REFB	Select a waveform to take the cursor measurement. Use the readouts to show the measurement.
Select Cursor	S E	S indicates Cursor 1. E indicates Cursor 2. A selected cursor is highlighted, which can be moved freely. Both cursors can be selected and moved at the same time. The box behind the cursor displays the location of the cursor.
Delta	Display the difference (delta) between the cursors.	Display the measurement in the box under this option.

Moving Cursors: Press the key F3 to select a cursor and move it with the Arrow key. Cursors can be moved only when the Cursor Menu is displayed.

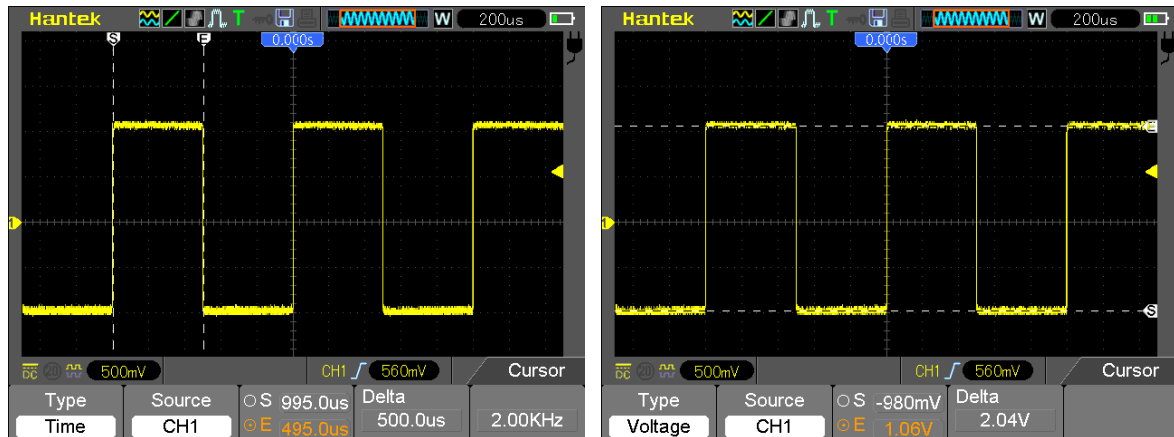

Time Cursor

Voltage Cursor

5.6 Fast Action Buttons



AUTORANGE: Automatically set the oscilloscope controls to generate a usable display of the input signals in real time.

AUTOSET: Automatically set the oscilloscope controls to generate a usable display of the input signals. Refer to the following table for relative content.

RUN/STOP: Continuously acquire waveforms or stop the acquisition.

5.6.1 AUTOSET

Autoset is one of the advantages digital oscilloscopes have. When you push the AUTO button, the oscilloscope will identify the type of waveform (sine or square wave) and adjust controls according to input signals so that it can accurately display the waveform of the input signal.

Functions	Settings
Acquire Mode	Adjusted to Normal or Peak Detect
Cursor	Off
Display Format	Set to YT
Display Type	Set to Vectors for an FFT spectrum; otherwise, unchanged
Horizontal Position	Adjusted
TIME/DIV	Adjusted
Trigger Coupling	Adjusted to DC, Noise Reject or HF Reject
Trigger Holdoff	Minimum

Trigger Level	Set to 50%
Trigger Mode	Auto
Trigger Source	Adjusted
Trigger Slope	Adjusted
Trigger Type	Edge
Trigger Video Sync	Adjusted
Trigger Video Standard	Adjusted
Vertical Bandwidth	Full
Vertical Coupling	DC (if GND was chosen before); AC for the video signal; otherwise, unchanged
VOLTS	Adjusted

The Autoset function examines all channels for signals and displays corresponding waveforms. Autoset determines the trigger source according to the following conditions.

- If multiply channels get signals, the oscilloscope will use the channel with the lowest frequency signal as the trigger source.
- If no signals are found, the oscilloscope will use the lowest-numbered channel displayed in Autoset as the trigger source.
- If no signals are found and no channels are displayed, the oscilloscope will display and use Channel 1 as the trigger source.

Sine Wave:

When you use the Autoset function and the oscilloscope determines that the signal is similar to a sine wave, the oscilloscope displays the following options.

Sine Wave Options	Details
Multi-cycle Sine	Display multiple cycles that have appropriate vertical and horizontal scales.
Single-cycle Sine	Set the horizontal scale to display about one cycle of the waveform.
Cancel	Let the oscilloscope recall the previous setup.

Square Wave or Pulse:

When you use the Autoset function and the oscilloscope determines that the signal is similar to a square wave or pulse, the oscilloscope displays the following options.

Square Wave Options	Details
Multi-cycle	Display multiple cycles that have appropriate vertical and horizontal scales.
Single-cycle	Set the horizontal scale to display about one cycle of the waveform. The oscilloscope displays Min, Mean and Positive Width automatic measurements.
Rising	Display the rising edge.
Falling	Display the falling edge.
Cancel	Let the oscilloscope recall the previous setup.

5.7 Signal Connectors

See the figure below to find the four signals connectors and a pair of metal electrodes at the bottom of the oscilloscope panel.

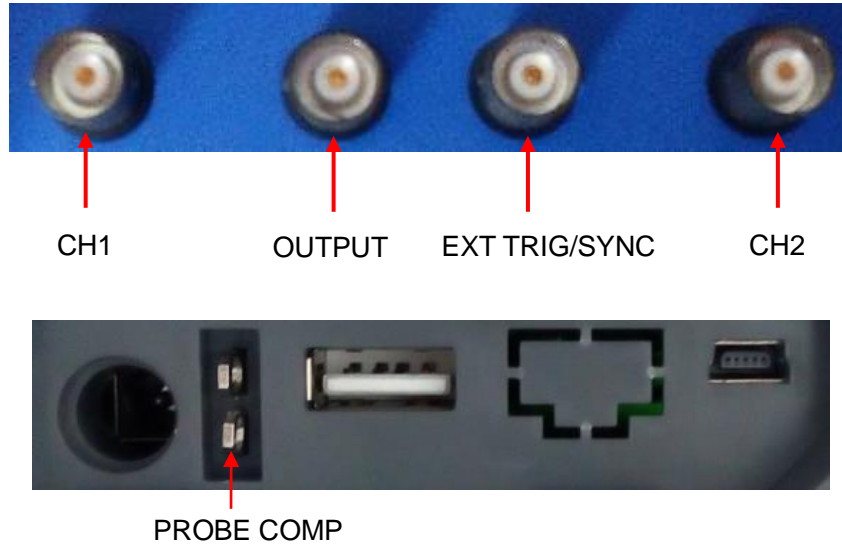

1. CH1, CH2: Input connectors for waveform display, through which to connect and input the signal to be measured.
2. OUTPUT: Waveform output BNC connector.
3. EXT TRIG/SYNC:
 - 1) Input connector for an external trigger source, though with to connect and input the external trigger signal.
 - 2) Sync output connector for waveform signal.
4. Probe COMP: Voltage probe compensation output and ground, used to electrically match the probe to the oscilloscope input circuit. The probe compensation ground and BNC shields connect to earth ground and are considered to be ground terminals. To avoid damages, do not connect a voltage source to any of these ground terminals.

Chapter 6 Application Examples

This chapter unfolds a further description on main features of the oscilloscope by giving eleven simplified application examples for reference to help solve your own test problems.

1. Taking simple measurements
 - Using AUTO
 - Using the Measure menu to take auto measurements
2. Taking cursor measurements
 - Measuring ring frequency and ring amplitude
 - Measuring pulse width
 - Measuring rise time
3. Analyzing input signals to eliminate random noise
 - Observing a noisy signal
 - Eliminating random noise
4. Capturing a single-shot signal
5. Using X-Y mode
6. Triggering on a pulse width
7. Triggering on a video signal
 - Observing triggers on video fields and video lines
8. Using Slope Trigger to capture a particular slope signal
9. Using Overtime Trigger to measure a long pulse signal
10. Using math functions to analyze waveforms
11. Measuring data propagation delay
12. Back light control
13. Auto shut down

6.1 Example 1: Taking Simple Measurements

When you want to observe an unknown signal in a certain circuit without having its amplitude and frequency parameters, you may use this function to take a fast measurement on the frequency, period and peak-to-peak amplitude of the signal.

Follow the steps below.

1. Set the switch on the oscilloscope probe to 10X;
2. Push the CH1 MENU button and set the Probe option attenuation to 10X;
3. Connect the CH1 probe to the test point of the circuit;
4. Press the AUTO button.

The oscilloscope will automatically set the waveform to a best display. If you want to further optimize the waveform display, you may manually adjust the vertical and horizontal controls until the waveform meets your particular requirement.

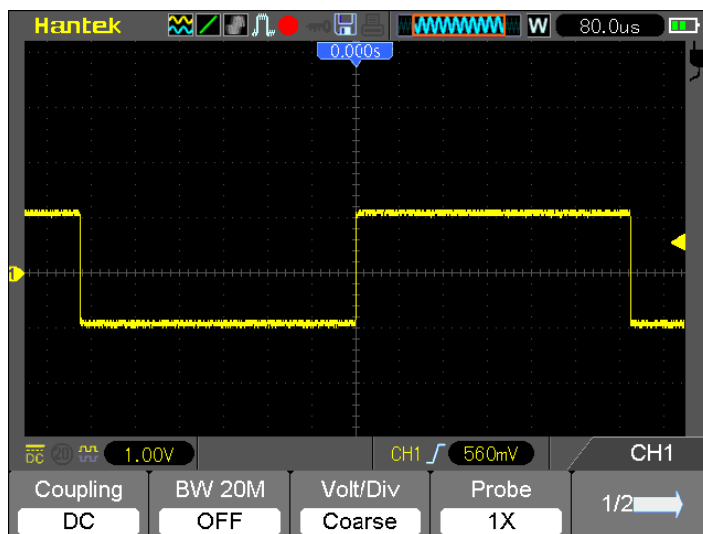

Taking Auto Measurements

The oscilloscope can display most signals by automatic measurements. To measure such parameters as the signal frequency, period, peak-to-peak amplitude, rise time and positive width, follow the steps below.

1. Push the MEAS button to see the Measure menu.
2. Select the first 'unspecified' option (marked by red arrow), and then enter the submenu.
3. Select CH1 for the Source option. Then repeatedly select measure items in the Type menu. Push the back menu to go back to the measure interface. The corresponding box under the measure item shows the measurements.
4. Repeat Step 2 and Step 3. Then select other measure items. Totally 4 measure items can be displayed.

Note: All readouts change with the measured signals.

The figure below shows three measure items as an example. The boxes under them display the measurements in large fonts.

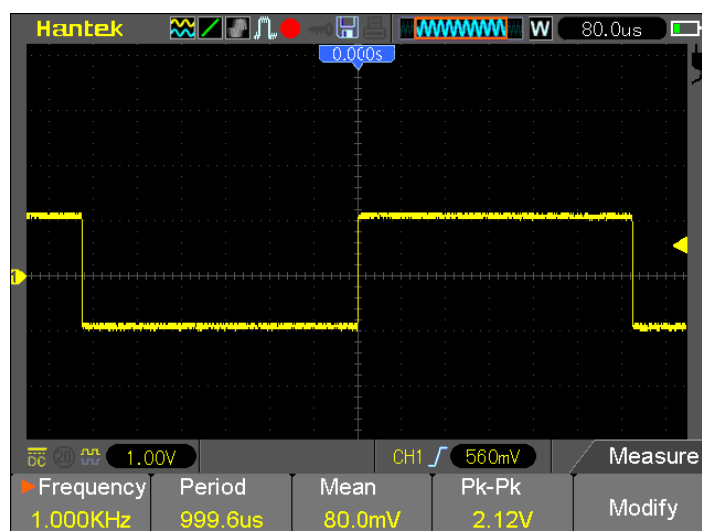

6.2 Example 2: Taking Cursor Measurements

You can use the cursor to quickly measure the time and amplitude of a waveform.

Measuring Ring Time (convertible to Frequency) and Amplitude on Rising Edge of Pulse

To measure the ring time on the rising edge of the pulse, follow the steps below.

1. Push the CURSOR button to view the Cursor menu.
2. Push F1 the Type option button and select Time.
3. Push F2 the Source option button and select CH1.
4. Select a cursor. If S is selected, move Cursor S on the screen; if E is selected, move Cursor E; if both are selected, move them at the same time.
5. Put Cursor S on the first peak of the ring.
6. Put Cursor E on the second peak of the ring.
7. At Delta displays the measured time and at Cursor S an Cursor E display the positions of these two cursors.
8. Push the Type option button and select Voltage.
9. Put Cursor S on the highest peak of the ring.
10. Put Cursor E on the lowest point of the ring. The amplitude of the ring will be displayed at Delta.

See figures below for better understanding.

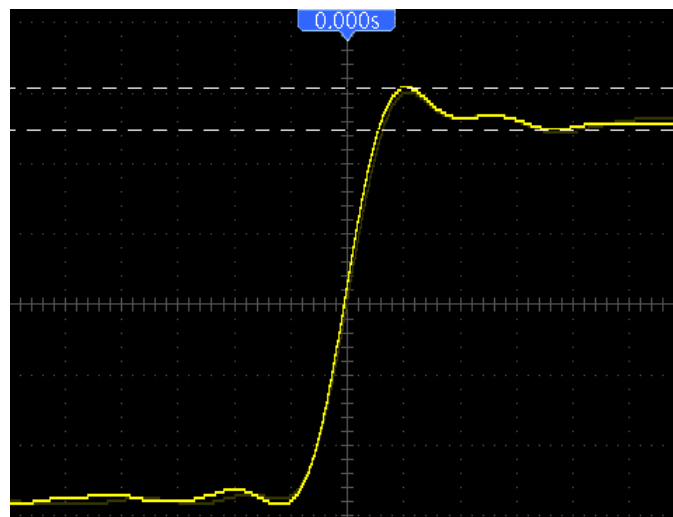
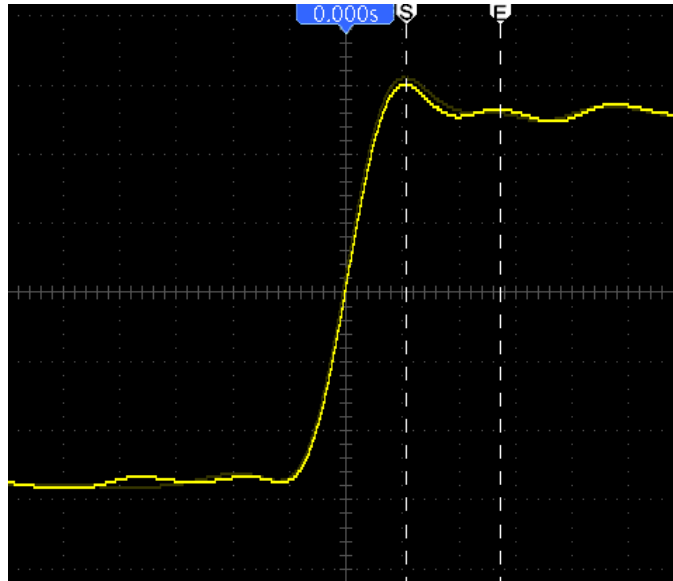

Measuring Pulse Width

To analyze a pulse signal and to know its width, follow the steps below.

1. Push the CURSOR button to view the Cursor menu.
2. Push F1 the Type option button and select Time.
3. Push F2 the Source option button and select CH1.
4. Select a cursor. If S is selected, move Cursor S on the screen; if E is selected, move Cursor E; if both are selected, move them at the same time.
5. Place Cursor S on the rising edge of the pulse and Cursor E on the falling edge.
6. Thus at Delta displays the measured time and at Cursor S and Cursor E displays the time relative to the trigger.

See the figure below for better understanding.

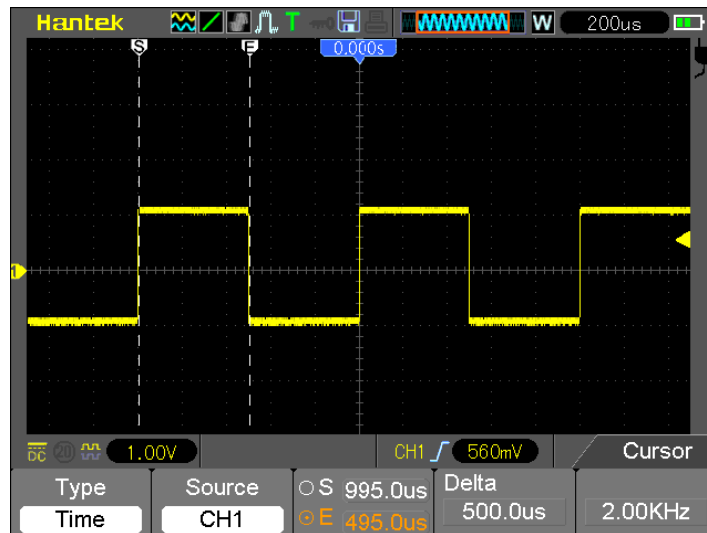

Measuring Rise Time of Pulse

You may need to measure the rise time of the pulse in many application environments, usually, to measure the rise time between the 10% and 90% levels of the pulse waveform. To do so, follow the steps below.

1. Click the TIME/DIV key to display the rising edge of the waveform.
2. Click the VOLTS and Vertical Position keys to adjust the waveform amplitude to about 5 divisions.
3. Push the CH1 MENU button.
4. Push the VOLTS option button and select Fine. Click the Vertical Position key to accurately separate the waveform into 5 divisions.
5. Click the Vertical Position key to center the waveform. Position the waveform baseline to 2.5 divisions below the center graticule.
6. Press the CURSOR button.
7. Push the Type option button and select Time. Push the Source option button to select CH1.
8. Select Cursor S and place it at the 10% level of the waveform.
9. Select Cursor E and place it at the 90% level of the waveform.
10. The Delta readout in the Cursor Menu is the rise time of the pulse.

See the figure below for better understanding.

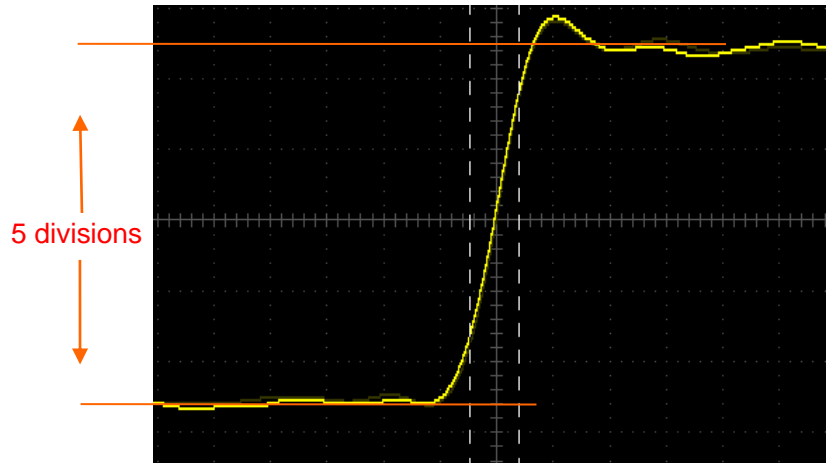

6.3 Example 3: Analyzing Input Signals to Eliminate Random Noise

In certain circumstances, to display a noisy signal on the oscilloscope and to get its details, you may follow the steps below to analyze this signal.

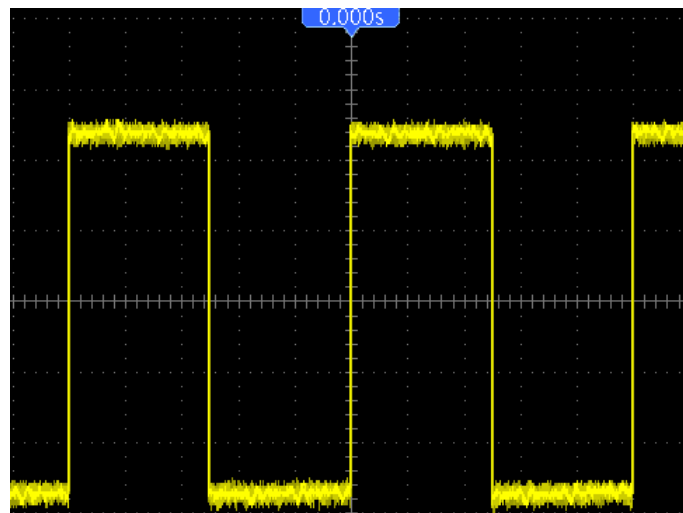

Observing Noisy Signal

1. Enter the Acquire menu.
2. Push the Type option button and select Real Time.
3. Push the Peak Detect option button.
4. If necessary, enter the DISPLAY menu and set the Contrast option to view the noise more clearly.

See the figure below for better understanding.

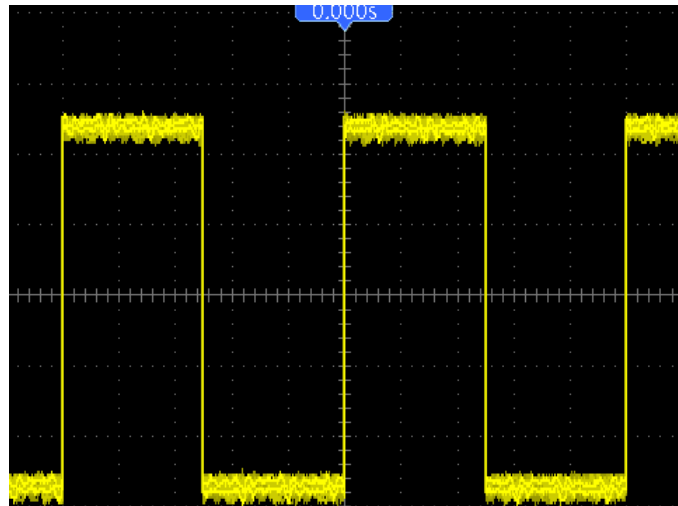

Eliminating Random Noise

1. Enter the Acquire menu.
2. Push the Type option button and select Real Time.
3. Push the Average option button.
4. Push the Averages option button and adjust the number of running averages to watch the change in the waveform display.

Note: *Averaging reduces random noise and let you view the signal details more easily.*

See the figure below for better understanding

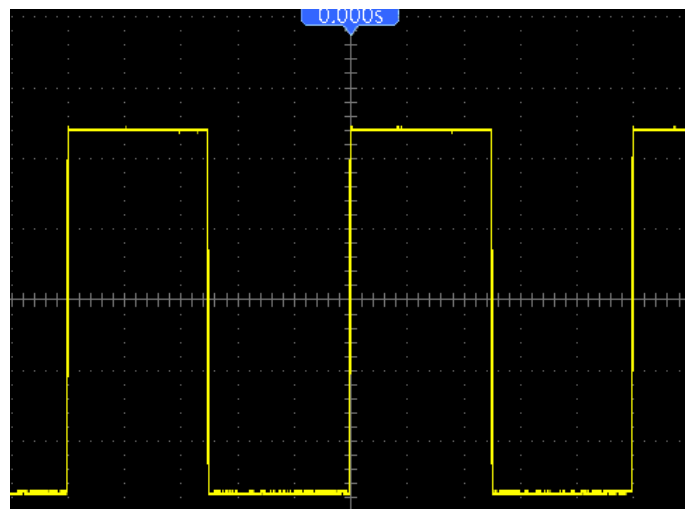

6.4 Example 4: Capturing Single-shot Signal

You may refer to the following example to easily capture some aperiodic signals like pulses and glitches.

To set for a single-shot acquisition, follow the steps below.

1. First, set up the oscilloscope probe and the attenuation factor of CH1.
2. Click the vertical VOLTS and horizontal TIME/DIV keys to a proper position for a better examination of the signal.
3. Enter the Acquire menu.
4. Push the Mode button to select Peak Detect.
5. Push the TRIG MENU button and select Rising for the Slope option. Then adjust the trigger level properly.
6. Select Single mode to start the acquisition.

Using this feature can help you to capture occasional events more easily. This is an advantage of the HandHeld oscilloscope.

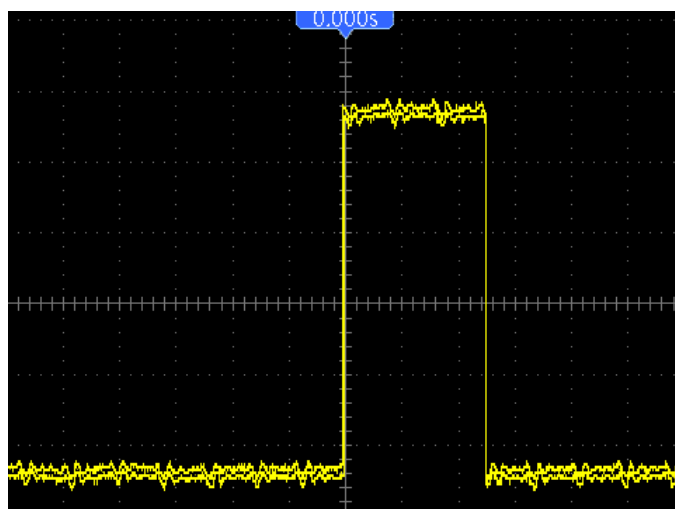

6.5 Example 5: Using X-Y Mode

Viewing Phase Differences between Two Channel Signals

For example, you need to measure the change in a phase across a circuit network.

Connect the oscilloscope with circuitry and view the input and output of the circuit in XY mode. Follow the steps below.

1. First, prepare two oscilloscope probes and set the switches to 10X on both probes.
2. Push the CH1 MENU button and set the Probe option attenuation to 10X; push the CH2 MENU button and set the Probe option attenuation to 10X.
3. Connect the CH1 probe to the input of the network, and connect the CH2 probe to the output.
4. Push the AUTO button.

5. Click the VOLTS keys to display approximately the same amplitude signals on each channel.
6. Enter the Display menu.
7. Push the DSO Mode button and select XY.
8. Now the oscilloscope displays a Lissajous pattern to characterize the input and output of the circuit.
9. Click the VOLTS and Vertical Position keys to properly scale the waveform display.
10. Use the Lissajous's oscillographic method to observe and calculate the phase differences following the formula below.

As $\sin\theta = A/B$ or C/D , in which θ is the phase difference angle between channels and A, B, C, D represent what shown in the figure below, you can get the value of the phase difference angle by the formula: $\theta = \pm \arcsin(A/B)$ or $\pm \arcsin(C/D)$.

If the principal axes of the ellipse are in the first and third quadrants, the phase difference angle should be in the first and fourth quadrants, i.e. within $(0 \sim \pi/2)$ or $(3\pi/2 \sim 2\pi)$. If the principal axes of the ellipse are in the second and fourth quadrants, the phase difference angle should be in the second and third quadrants, i.e. within $(\pi/2 \sim \pi)$ or $(\pi - 3\pi/2)$. See the figure below for better understanding.

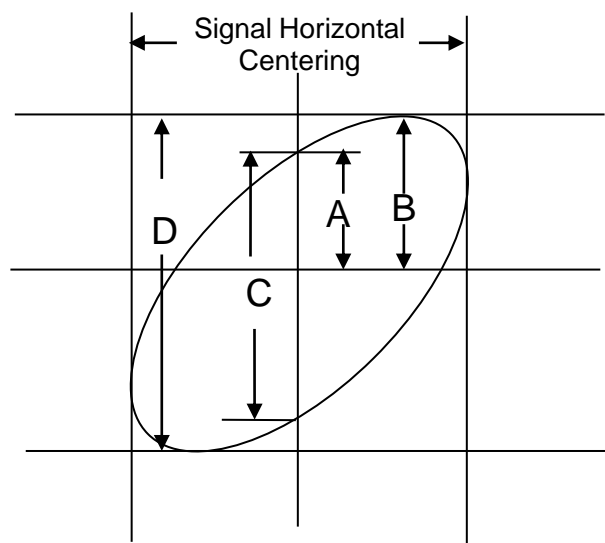

6.6 Example 6: Triggering on Pulse Width

Triggering on a Specific Pulse Width

While testing the pulse width of a signal in a circuit, you may need to verify the pulse width is consistent with the theoretic value. Or even if the edge triggering shows that your signal has the same pulse width with the specific signal, you still doubt about the result. Then you can follow the steps below.

1. Set the Probe option attenuation to 10X.

2. Push the AUTO button to trigger a stable waveform display.
3. Push the Single Cycle option button in the Autoset menu and read out the signal pulse width.
4. Push the TRIG MENU button.
5. Select Pulse for the Type option; Select CH1 for the Source option; Click the TRIGGER LEVEL key to set the trigger level at the bottom of the signal.
6. Select the When option button and select '='.
7. Push the Set Pulse Width option button. Set the pulse width to the value read out in Step 3.
8. Click the TRIGGER LEVEL key to set the pulse width to the value read out in Step 3.
9. Push the More option button and select Normal for the Mode option. Once triggering on normal pulses, the oscilloscope can give a stable waveform display.
10. When option is set to >, < or ≠ and there appear any aberrant pulses that meet the specified condition, the oscilloscope will trigger. For example, the signal contains such aberrant pulses as shown below, you may select '≠' or '<' to trigger on the pulse.

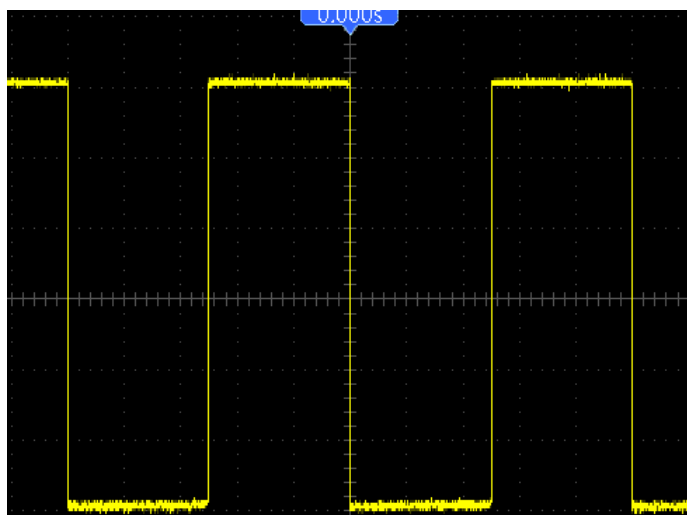

As shown in the above figure, you can get a stable waveform display if inputting a square wave at the frequency of 1KHz, with pulse width set to 500 μ s.

6.7 Example 7: Triggering on Video Signal

Assume that you are monitoring the video signals of a television to see if they are input normally, and the video signal is of an NTSC system. You can get a stable display by using the video trigger.

Triggering on Video Fields

To trigger on the video fields, follow the steps below.

1. Push the TRIG MENU button to see the Trigger menu.
2. Push F1 to select Video for the Type option.

3. Push the Source option button to select CH1; push the Polarity option button to select Normal; push the Standard option button to select NTSC.
4. Push the Sync option button to select Odd Field, Even Field or All Fields.
5. Push the Trigger Level button to adjust the trigger level and stabilize video signals.
6. Push the horizontal TIME/DIV and the Vertical Position keys to display on the screen a complete video signal triggering on a video field.

The figure below shows a stable signal triggering on a video field.

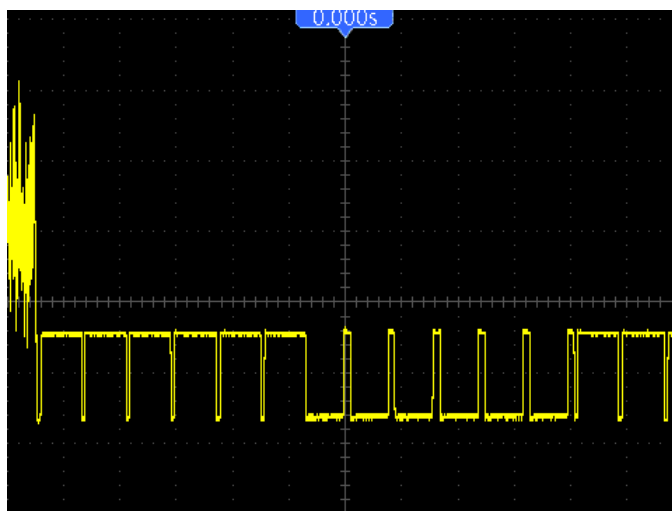

Triggering on Video Lines

To trigger on the video lines, follow the steps below.

1. Push the TRIG MENU button to see the Trigger menu.
2. Select Video for the Type option.
3. Push the Source option button to select CH1; push the Polarity option button to select Normal; push the Standard option button to select NTSC; push the Sync option button to select Line Number.
4. Click the Trigger Level key to adjust the trigger level and stabilize video signals.
5. Adjust the line number (NTSC: 0-525 lines).
6. Click the horizontal TIME/DIV and the vertical VOLTS keys to display on the screen a complete video signal triggering on a video line. See the figure below.

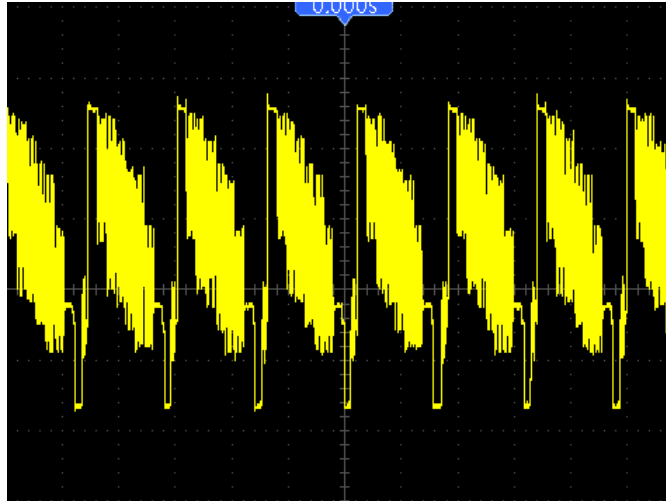

6.8 Example 8: Using Slope Trigger to Capture Particular Slope Signal

In many occasions, we are not only concerned about the edge of the signal, but also want to know the rise and fall times of the signal. To better observe this kind of signals, we bring in the slope trigger. Follow the steps below.

1. Push the TRIG MENU button to see the Trigger menu.
2. Select Slope for the Type option.
3. Push the Source option button to select CH1; push the Slope option button to select Rising; push the Mode option button to select Auto; push the Coupling option button to select DC.
4. Click the 'Next Page' button and select Vertical. Adjust V1 and V2 to proper locations. Select the When option button and set it to '='.
5. Select 'Time' and adjust the time until you get a stable display of waveforms. See the figure below.

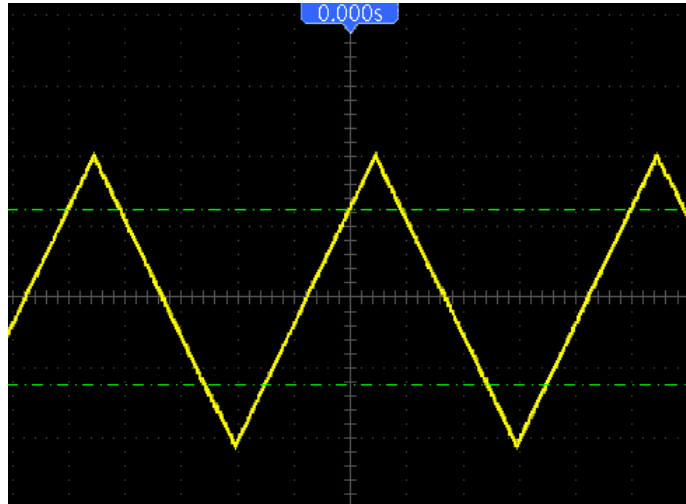

6.9 Example 9: Using Overtime Trigger to Measure Long Pulse Signal

Pulse Signal

It is not easy to observe some part of a long pulse signal by using the edge or pulse width trigger. In such case, you can use the overtime trigger by following steps.

1. Push the TRIG MENU button to see the Trigger menu.
2. Select O.T. for the Type option; push the Polarity option button to select Normal; push the Mode option button to select Auto; push the Coupling option button to select DC.
3. Click the Trigger Level key to adjust the trigger level and stabilize video signals.
4. Adjust the line number (NTSC: 0-525 lines).
5. Click the horizontal TIME/DIV and the vertical VOLTS keys to display on the screen a complete video signal triggering on a video line. See the figure below.

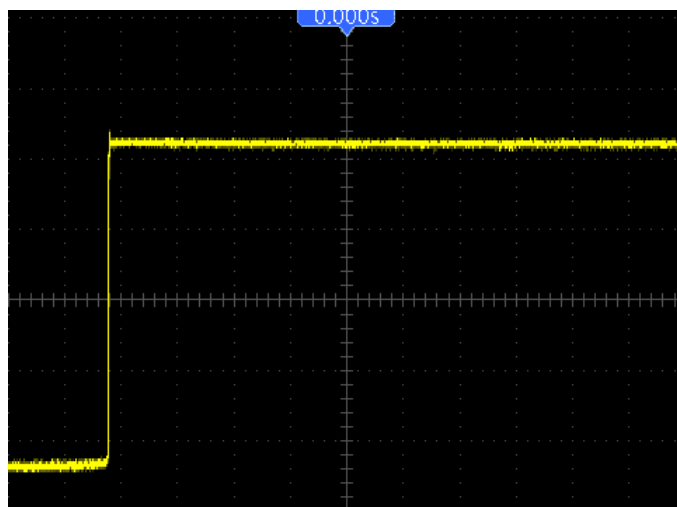

Note: The difference between the overtime and the delay triggers is that the overtime trigger can identify the pulse you need according to your set time and trigger on any point of the pulse. In the other word, the overtime trigger occurs based on pulse identification. It is similar to the > mode of the pulse width trigger, but not the same.

6.10 Example 10: Using Math Functions to Analyze Waveforms

Using math functions to analyze input waveforms is another advantage of the digital oscilloscope. For example, you want to get the instantaneous difference between two channel waveforms. By using the math function of the oscilloscope, you can get a better representation of the waveform on the screen. To observe this signal, follow the steps below.

1. Set the Probe option attenuation to 10X.
2. Open CH1 and CH2 at the same time, both with the attenuation of 10X.
3. Push the AUTO button to trigger a stable waveform.
4. Push the M/R MENU button to see the Math menu.
5. Push the Operation option button and select 'CH1+CH2'.
6. Click the horizontal TIME/DIV and the vertical VOLTS keys to properly scale the waveform for easy check.

In addition, the oscilloscope also supports the - and FFT functions. For a detailed analysis on FFT, refer to [Chapter 5.3.1 Math FFT](#).

Note: You should compensate both probes before performing the math operation; otherwise, differences in probe compensation will appear as errors in the differential signal.

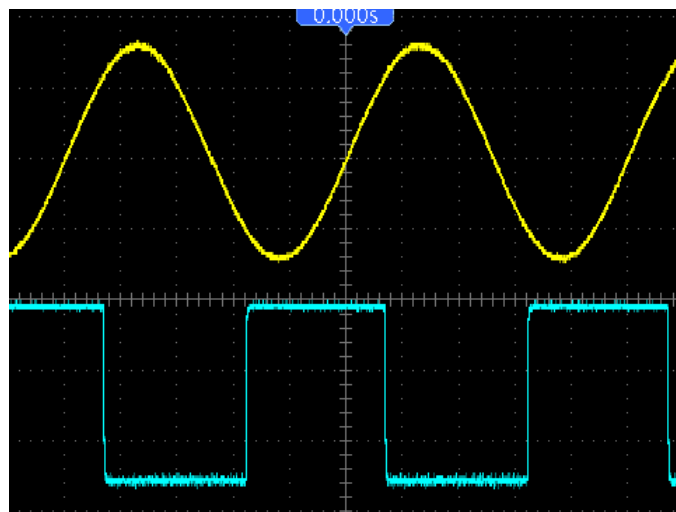

As illustrated in the above figure, input a 1KHz sine wave from CH1 and a 1KHz square wave

from CH2.

Follow the above steps to set up the Math menu, and observe the subtracted waveform as shown in the figure below.

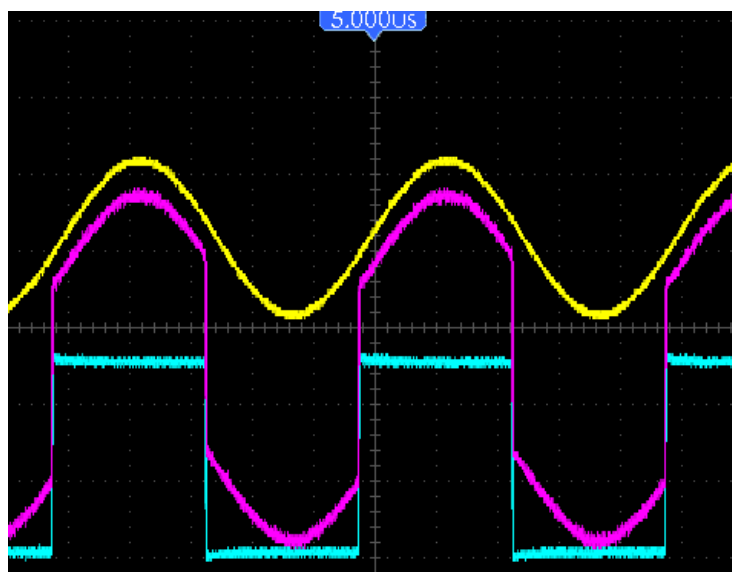

Those in pink are added waveforms.

6.11 Example 11: Measuring Data Propagation Delay

When you doubt that there appear instabilities in a serial data propagation control circuit, you can set the oscilloscope to measure the propagation delay between the enable signal and the transfer data.

To set the propagation delay measurement, follow the steps below.

1. Connect two oscilloscope probes respectively to the CS (chip-select) pin and the DATA pin on the chip.
2. Set the Probe option attenuation to 10X for both probes.
3. Open CH1 and CH2 at the same time, both with the attenuation of 10X.
4. Push the AUTO button to trigger a stable waveform display.
5. Adjust the horizontal and vertical controls to optimize the waveform display.
6. Push the CURSOR button to view the Cursor menu.
7. Push the Type option button and select Time.
8. Select Cursor S and place it on the active edge of the enable signal.
9. Select Cursor E and place it on the data output transition (See the figure below).

10. Read the data propagation delay in the Delta readout.

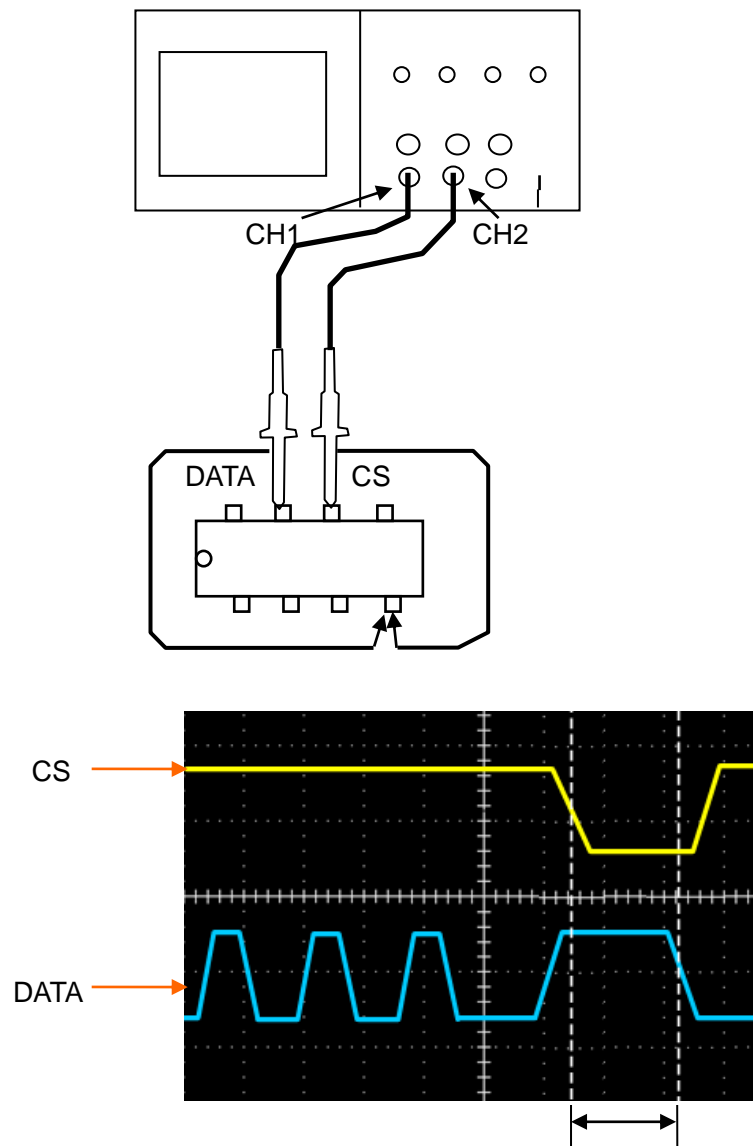

6.12 Example 12: Back light control

1. Press the UTILITY button, entering the UTILITY menu.
2. Press F5 to page down.
3. After reaching the page four, then press F3 to enter the Display menu.
4. Press F5 button to page 3 of display menu, press F3.
5. Set backlight time using the direction button.

6.13 Example 13: Auto shut down

1. Press the UTILITY button, entering the UTILITY menu.
2. Press F5 to page down.
3. After reaching the page two, then press F3 to enter the Shutdown menu.
4. Press F1 button to select PowerOff, press F2 to select Time then set the time using the direction button.
5. Press F3 button to confirm.

6.14 Example 14: Connect with PC via LAN (Optional)

To set net IP, follow the steps below.

1. Select the menu Utility->System->Pc Set->Mode->NET. Then push up the NetCfg dialog.

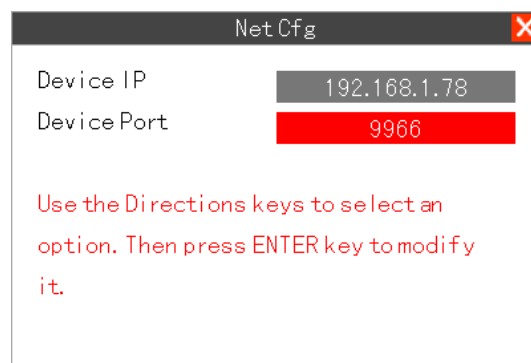

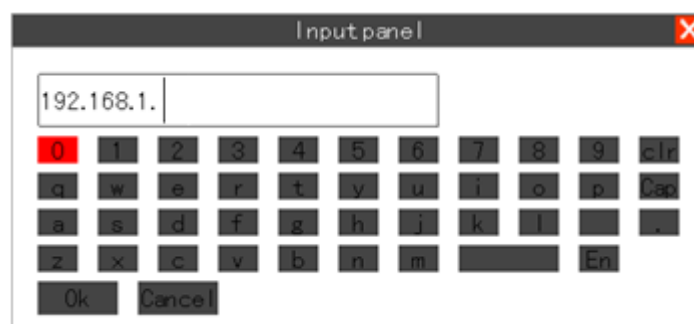

2. Select Device IP or Device Port you want to set and press ENTER key. Then push up the Input panel dialog.

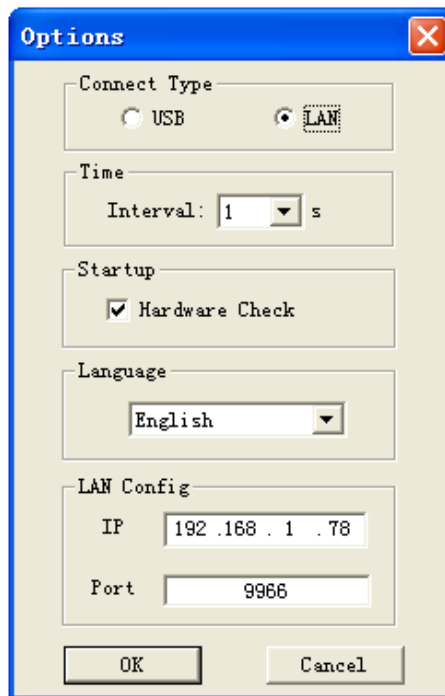

3. Modify the parameter by the soft keyboard.
4. If user observe signal on software, please set connect type "LAN" simultaneously. Click  in

toolbar.



Note: If user want to connect the device with PC by USB port again, please select the menu Utility->System->Pc Set->Mode->USB. If user observe signal on software, please set connect type "USB" simultaneously. Click  in toolbar.

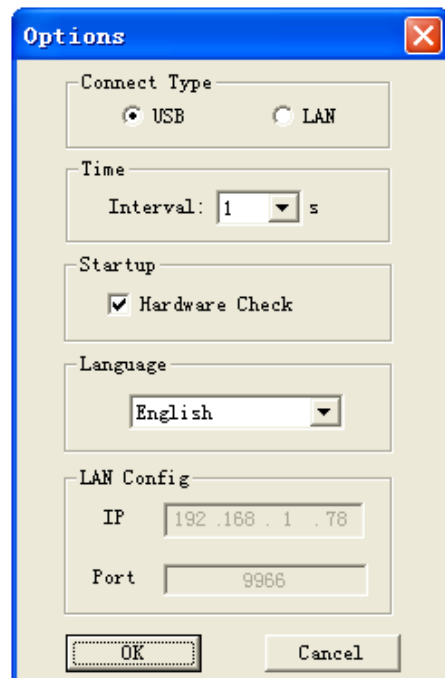

6.15 Example 15: Charging

Your battery has been partially charged at the factory, but you may need to recharge it before you

can switch on your device for the first time.

If the device indicates a low charge, do the following:

1. Connect the Oscilloscope to the power source by the switching adapter.
2. You do not need to charge the battery for a specific length of time, and you can use the device while it is charging.

If the battery has not been used for a long time, to begin charging, you may need to connect the charger, then disconnect and reconnect it.

Note: The oscilloscope can be charged whatever it is on or off. It needs 5 hours for charging the battery when the oscilloscope is off. It needs about 12 hours for charging the battery when the oscilloscope is on. The length of the charging time depends on the different battery.

Battery Type: 7.4V

Chapter 7 Multimeter

About this chapter

This chapter provides an introduction to the multimeter functions of DSO8000E Series. The introduction gives guides to show how to use the menus and perform basic measurements.

Connecting the Meter

Use the 4-mm safety banana jack inputs for the Meter functions: 10A , mA, COM,V/ Ω /C.

Multimeter Operation Window

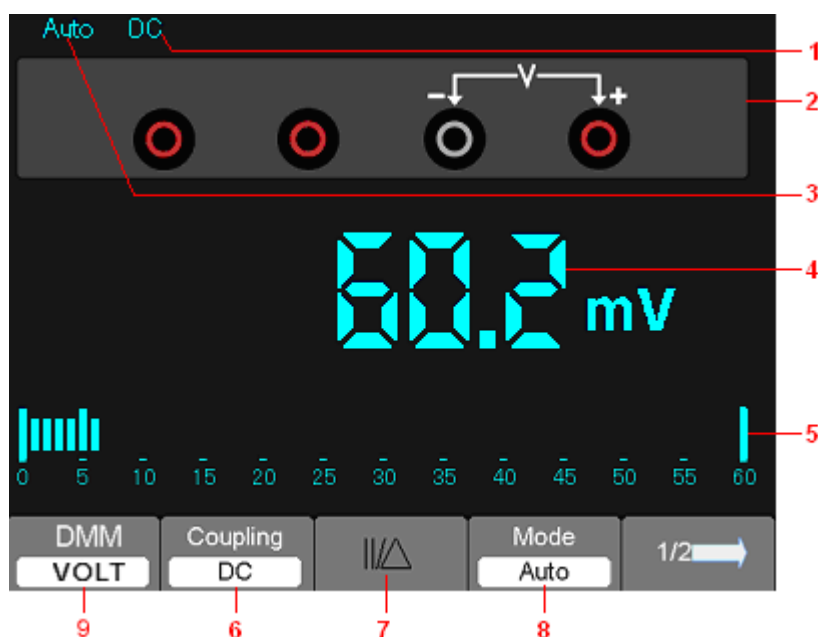

Figure 7-1 Multimeter operation window

Description

1) Measurement mode indicators:

DC: Direct electric measurement

AC: Alternating electric measurement

2) The symbol of Multimeter current mode.

3) Manual/Auto range indicators, among which the MANUAL refers to measuring range in manual operation mode and Auto means the measuring range in automatic operation mode.

4) The reading value of measurement.

5) The bar graph indicator.

6) DC or AC Measurement mode control.

7) Absolute /relative magnitude measuring control: The sign “||” expresses the absolute magnitude measuring control and “ / ” represents the relative magnitude measuring control.

8) Manually or automatically measuring range control.

9) Measure type, including VOLT, A, OHM, DIODE, CON, CAP.

Operating the Multimeter

If you are in the oscilloscope window, press **SCOPE/DMM** key, the oscilloscope will switch to the multimeter mode window. Then the screen will display the measure mode window that was in use the last time before you quit multimeter measure. When you switch to the multimeter measurement the first time, the default measure mode is DC voltage mode.

Measuring Resistance Values

To measure a resistance, do the following:

- 1) Press the F1 key to select OHM then resistance measurement window appears on the screen.
- 2) Insert the black lead into the COM banana jack input and the red lead into the V/O/C banana jack input.
- 3) Connect the red and black test leads to the resistor. The resistance value is shown on the screen in Ohm.

Then, the screen will look like the following figure 7-2.



Figure 7-2 Resistance Measurement

Making a Diode Measurement

To make a measurement on the diode, do the following:

- 1) Press the F1 key to select DIODE and a diode symbol appears at the top of the screen. .
- 2) Insert the black lead into the COM banana jack input and the red lead into the V/O/C banana jack input.
- 3) Connect the red and black leads to the diode and the voltage value of the diode is displayed on the screen in volt.

Then, the screen will look like the following figure 7-3.



Figure 7-3 Diode Measurement

Making an On-off Measurement

To perform an On-off test, do the following:

- 1) Press the F1 key to select CON and then On-off indicator appears on the top of the screen.
- 2) Insert the black lead into the COM banana jack input and the red lead into the V/O/C banana jack input.
- 3) Connect the red and black leads to the tested points. If the resistance value of the tested points is less than 30 Ω , you will hear beep sound from the test tool.

Then, the screen will look like the following figure 7-4.

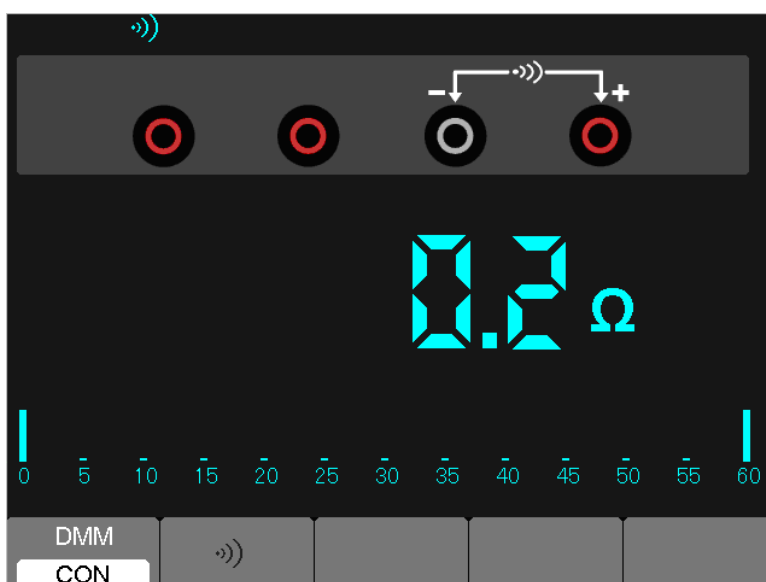

Figure 7-4 On-off Measurement

Making a Capacitance Measurement

To measure a capacitance, do the following:

- 1) Press the F1 key to select CAP and a capacitor symbol appears on the top of the screen.
- 2) Insert the black lead into the COM banana jack input and the red lead into the V/O/C banana jack input.
- 3) Connect the red and black leads to the capacitor and the capacitance value is displayed on the screen in μF or nF .

Then, the screen will look like the following figure 7-5.



Figure 7-5 Capacitance Measurement

Making a DC Voltage Measurement

To measure a DC voltage, do the following:

1. Press the F1 key to select VOLT and DC appears at the top of the screen.
2. Insert the black lead into the COM banana jack input and the red lead into the V/O/C banana jack input.
3. Connect the red and black leads to the measured points and the voltage value of measured points is displayed on the screen.

Then ,the screen will look like the following figure 7-6.



Figure 7-6 DC voltage Measurement

Making an AC Voltage Measurement

To measure the AC voltage, do the following:

- 1) Press the F1 key to select VOLT and DC appears on the screen.
- 2) Press the F2 key and AC appears on the screen.
- 3) Insert the black lead into the COM banana jack input and the red lead into the V/O/C banana jack input.
- 4) Connect the red and black leads to the measured points and the AC voltage value of measured points will be displayed on the screen.

Then, the screen will look like the following figure 7-7.



Figure 7-7 AC voltage Measurement

Making a DC Current Measurement

To measure a DC current which is less than 600 mA , do the following:

- 1) Press the F1 key to select A and then DC appears on the screen. The unit on the main reading screen is mA. Press F3 to switch the measurement between mA and 10A. 600mA is acquiescently.
- 2) Insert the black lead into the COM banana jack input and the red lead into the mA banana jack input.
- 3) Connect the red and black leads to the measured points and the DC current value of measured points will be displayed on the screen.

Then, the screen will look like the following figure 7-8.



Figure 7-8 DC current Measurement for 600 Measurement

To measure a DC current which is larger than 600 mA, do the following:

- 1) Press the F1 key to select A and then DC appears on the screen. The unit on the main reading screen is mA.
- 2) Press F3 key to switch to 10A measurement, the unit on the main reading screen is A.
- 3) Insert the black lead into the COM banana jack input and the red lead into the 10A banana jack input.
- 4) Connect the red and black leads to the measured points and the DC current value of the measured points will be displayed on the screen.
- 5) Press F2 to return to 600 mA measurement.

Then, the screen will look like the following figure 7-9.



Figure 7-9 DC Current Measurement for 10A

Making an AC Current Measurement

To measure an AC current which is less than 600 mA, do the following:

- 1) Press the F1 key to select A and then DC appears on the screen. The unit on the main reading screen is mA, and mA will display on the bottom of the screen, press F2 to switch the measurement between mA and 10A. 600mA is acquiescently.
- 2) Press the F2 key once and AC will display on the bottom of the screen.
- 3) Insert the black lead into the COM banana jack input and the red lead into the mA banana jack input.
- 4) Connect the red and black leads to the measured points and the AC current value of measured points will be displayed on the screen.

Then, the screen will look like the following figure 7-10.



Figure 7-10 AC Current Measurement for 600 mA

To measure an AC current which is larger than 600 mA, do the following:

- 1) Press the F1 key to select A and then DC appears on the screen. The unit on the main reading screen is mA.
- 2) Press F3 key to switch to 10A measurement, the unit on the main reading screen is A.
- 3) Press the F1 key once and AC will display on the bottom of the screen.
- 4) Insert the black lead into the COM banana jack input and the red lead into the 10A banana jack input.
- 5) Connect the red and black leads to the measured points and the AC current value of the measured points will be displayed on the screen.
- 6) Press F3 to return to 600 mA measurement.

Then, the screen will look like the following figure 7-11.



Figure 7-11 AC Current Measurement for 10A

Taking a Relative Measurement

A currently measured result relative to the defined reference value is displayed in a relative measurement.

The following example shows how to take a relative measurement. At first, it is required to acquire a reference value.

- 1) Press the OHM.
- 2) Insert the black lead into the COM banana jack input and the red lead into the V/O/C banana jack input.
- 3) Connect the red and black test leads to the resistor. The resistance value is shown on the screen in Ohm.
- 4) When the reading leveling off, press F2 key and then ||/Δ is displayed on the top of the screen. The saved reference value is displayed beside.

Then, the screen will look like the following figure 7-12.



Figure 7-12 Relative Measurement

Selecting Automatic/Manual Range Adjustment

The default range mode of the instrument is automatic range. Suppose you are using the DC voltage mode, to switch to the manual range, perform the following steps:

- 1) Press F3 key to enter the manual range mode and then Manual is displayed on the top of the screen.
- 2) Under the manual range mode, the measuring range is increased by a stage when pressing F4 key each time, and when reaching the highest stage, it jumps to the lowest stage by pressing F4 key once again.
- 3) Press F3 key to switch back to the automatic range mode and then Auto is displayed on the top of the screen.

Attention: capacitance measurement without manual range mode.

Then, the screen will look like the following figure 7-13.

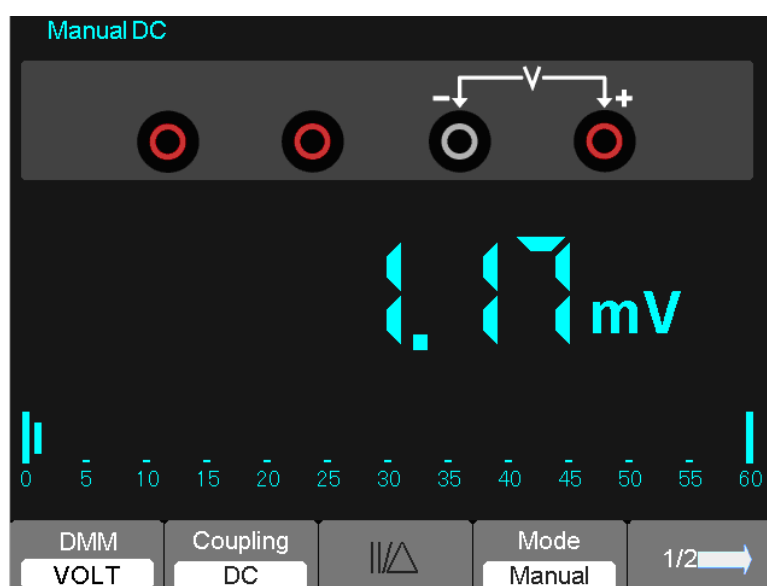

Figure 7-13 The Manual Range Mode

Chapter 8 Recorder

About this Chapter

This chapter provides a step-by-step introduction to the recorder functions of DSO8000E series Handheld Digital Oscilloscope. The introduction gives basic examples to show how to use the menus and perform basic operations.

The recorder mainly includes the following functions:

Trend Plot: Trend plot is to save the measurements in the memory and then plot a graph of Scope or Meter measurements as a function of time. The maximal recording length of trend plot is 1.2M data points.

Waveform Recorder: Record real time waveform without gap or space. That is to say every time the device can save all captured waveform data and then replay them. The maximal recording length of waveform recorder is 8M data points.

8.1 Multimeter Trend

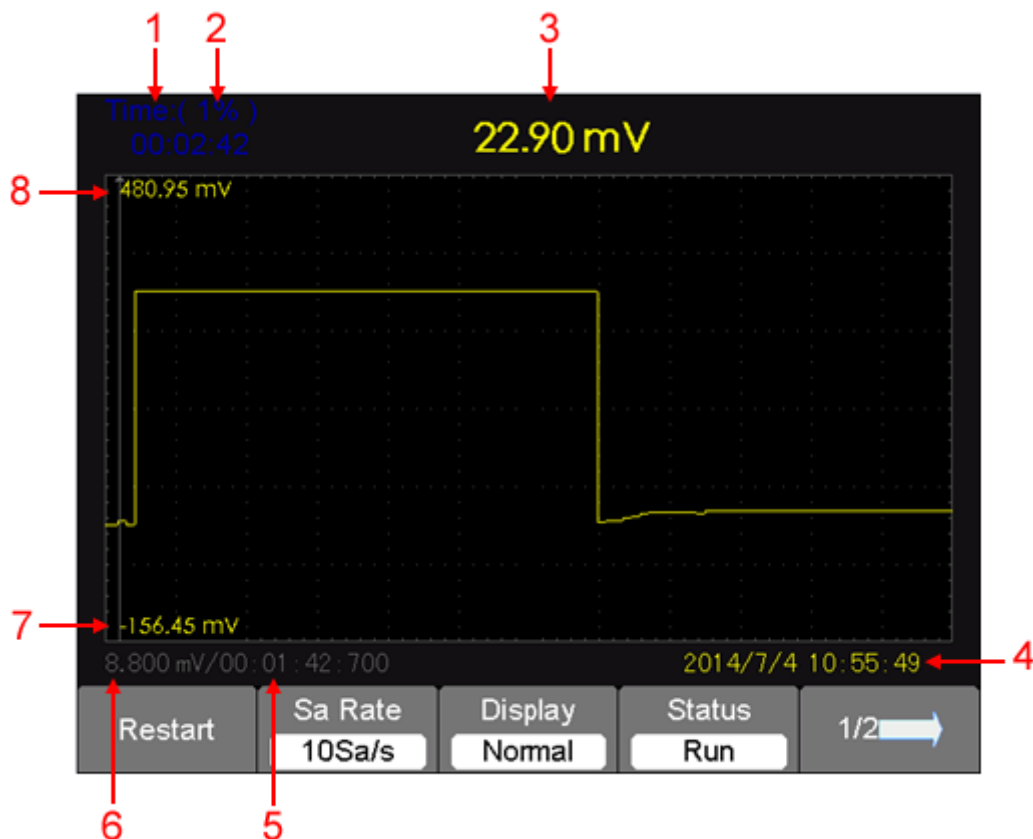

1. Current recorded time
2. The percentage of the current data in the whole memory
3. The parameter value of the recorded data at the moment
4. The real time
5. The sample time of the cursor point.
6. The parameter measurement value of the cursor point
7. Vertical scale
8. Vertical scale

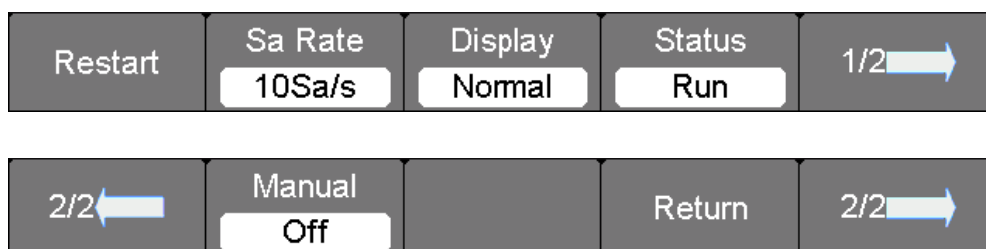

Multimeter Trend Function Menu

Function	Setting	Instruction
Restart		Quit the current data and start to record afresh.
Sa Rate	10Sa...0.005Sa	Set sampling rate

Display mode	normal	Display the recorded data up to the minute.
	All view	Display all dots.
Record Status	Run	Record data automatically
	Stop	Stop record data
1/2		Enter the second page of the menu
Manual	Off	Record data automatically
	On	Record data manually. A Record presses a record.
Return		Return to the multimeter function state
2/2		Return to the first page.

Multimeter trend application example

Start trend function

Operation steps:

1. Input a measured signal correctly. See [chapter 7 Multimeter](#).
2. Press **【F4】** or **【F5】** to enter Trend at the multimeter main menu.

Also user can press "RECORDER" button to enter the "Trend".

The device will record the measurement value of the input port continuously and plot measurements over time.

3. Press **【F4】** to stop or run recording data.
4. At the second page of the menu you can choose manual or auto mode to record the data. After select Manual as "On", record data manually. A Record presses a record.

Display the record data

5. Press **【F3】** to choose data display mode.

Normal mode: the screen displays the data up to the minute. The recorded data before saved in the memorizer.

All view mode: the screen display all recorded data in the memorizer.

6. Data analysis: move cursor, analyzing data over time. Please press direction key to move cursor.
7. Press **【Return】** to exit trend.

8.2 Oscilloscope Trend

Scope Trend Function Menu

Option	Setting	Instruction
Restart		Quit the current data and start to record afresh.
Source	Select the source	CH1, CH2
Param	Choose the parameter to be	Mean, Pk-Pk, Frequency, Period, Minimum, Maximum

	measured.	
Status	Run	Continue recording data
	Stop	Stop or continue recording data
1/2		Enter the second page of the menu.
Display	Normal	Display the data up to the minute
	View All	Display all date in a compressing proportion
Manual	Off	Record data automatically
	On	Record data manually. A Record presses a record.
Return		Return to the oscilloscope interface
2/2		Return to the first page of the menu

First choose a source and a measurement. You can choose the recorder functions from the waveform recorder main menu. To open the main menu, do the following:

Press **【Recorder】** to open the recorder main menu.

Scope Trend Application Example

Operation steps:

Open trend function

1. Input a signal to CH1 or CH2.
2. Press **【Recorder】** to enter the recorder main menu.
3. Press **【F2】** to choose **ScopeTrend**.
4. Choose measured **parameter** and start recording the trend plot.
5. Press **【F4】** to pause or continue recording data.

Display recorded data

6. Press **【F5】** to enter the second page of trend plot menu.
7. Press **【F1】** to choose data display mode.

Normal: the screen displays the data up to the minute.

View All: the screen displays all data in the memory.

8. Data analysis: move cursor, analyzing data over time.

9. Press **Return** to exit trend plot.

8.3 Waveform Recorder

Press **【Recorder】** to enter recorder main menu under scan time base, then press **【F2】** to choose **ScopeRec**.



Waveform Recorder Function Menu

Option	Instruction
Record	Record waveform without gap.
Replay	Replay the recorded waveform.
Return	Exit waveform recorder function



Waveform Recorder Saving Mode Function Menu

Option	Instruction
Start	Begin to record waveform
Pause	Stop to record waveform
Restart	
Mode	Continuous: Single:
1/2	Enter the second page of the menu.
Save	Choose a place to save record, including memory USB flash disk
File List	Open file list
Return	Exit the submenu and return to the waveform recorder main
2/2	Return to the first page of the menu

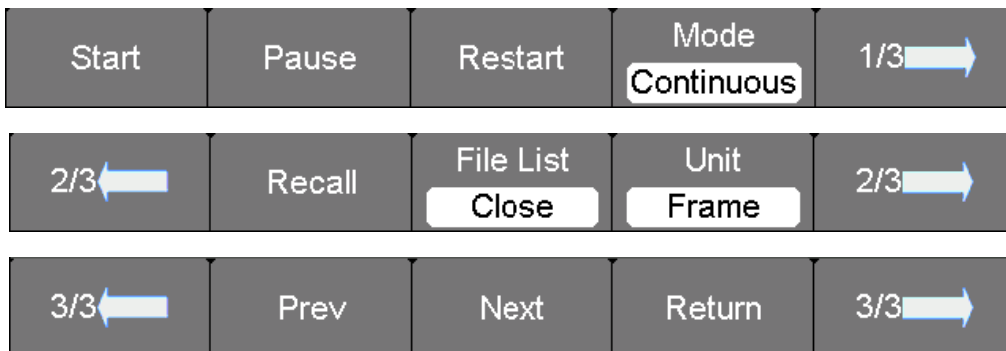

Waveform Recorder Replaying Mode Function Menu

Option	Instruction
Start	Pause playing waveform automatically, you can change the time base to observe the waveform in the memory.
Pause	Continue playing waveform automatically, you can change the time base to observe the waveform in the memory.
Restart	Replay the waveform
Mode	Continuous:

	Single:
1/3	Enter the second page of the menu.
Recall	Recall the waveform stored in the memory
File List	Open or close file list
Unit	Frame: When replaying the screen waveform updates the whole screen according to the time of sampling every frame data Point: When replaying, the screen waveform updates every dot from left to right.
2/3	Enter the third page of the menu.
Prev	Back the waveform and then play.
Next	Speed the playing of the waveform.
Return	Exit the replaying menu.
3/3	Return to the first page of the menu

Waveform recorder application example

Startup the waveform recorder function:

1. Press **【Recorder】** to open the main menu.
2. Press **【F3】** to choose **scopeRec**.
3. Press **【F1】** to set the waveform recorder. Such as set “Continuous” and “Single”.
4. Press **【F1】** to start recording data.

The waveform will not move right and the recorded data saved to memory. The recorded time will be different according to the time base. You can pause or stop at any time.

Waveform replay

5. Press **【F2】** to replay waveform.

You can replay the recorded waveform for several times and you can Prev or Next at any time.

6. Press **【F5】** to exit the waveform recorder.

Chapter 9 Waveform Generator

DSO8000E Series oscilloscope is equipped with waveform generator function, with one channel of arbitrary waveform output, 8 Bits output, synchronized signal outputs. User can edit the waveform by the mouse or choose the regular waveforms such as Sine, Ramp, Square, Trapezia, DC, Exponent, AM/FM.

9.1 Waveform Generator

Waveform Parameter Setup

Select a wave type, and you can set the “**Parameters**” by the near key.

Generate the Sine waveform

To output a Sine Wave, please do the following steps:

1. Press F1 button to select "Sine".

2. Set the Wave Parameter:

Frequency: Set the output wave frequency.

Amplitude: Set the output wave amplitude.

Offset: Set the output wave vertical level offset.

Sync Out: Turn on or turn off synchronous output.

OutPut: Select waveform output type, Continuous, single or trun off.

EXT Trig: Turn on or turn off external trigger, rise edge or fall eage.

Generate the Ramp waveform

To output a Ramp Wave, please do the following steps:

1. Press F1 button to select "Ramp".

2. Set the Wave Parameter:

Frequency: Set the output wave frequency.

Amplitude: Set the output wave amplitude.

Offset: Set the output wave vertical level offset.

Duty: The duty of the output wave.

Sync Out: Turn on or turn off synchronous output.

OutPut: Select waveform output type, Continuous, single or trun off.

EXT Trig: Turn on or turn off external trigger, rise edge or fall eage.

Generate the Square waveform

To output a Square Wave, please do the following Step:

1. Press F1 button to select "Square".
 2. Set the Wave Parameter:
 - Frequency: Set the output wave frequency.
 - Amplitude: Set the output wave amplitude.
 - Offset: Set the output wave vertical level offset.
 - Duty: The duty of the output wave.
- Sync Out: Turn on or turn off synchronous output.
- OutPut: Select waveform output type, Continuous, single or trun off.
- EXT Trig: Turn on or turn off external trigger, rise edge or fall eage.

Generate the Trapezia waveform

To output a Trapezia wave, please do the following steps:

1. Press F2 button to select "Trap".
 2. Set the Wave Parameter:
 - Frequency: Set the output wave frequency.
 - Amplitude: Set the output wave amplitude.
 - Offset: Set the output wave vertical level offset.
 - Duty: The duty of the output wave.
 - Rise Duty: Set the output wave rise duty.
 - High Duty: Set the output wave high duty.
 - Fall Duty: Set the output wave fall duty.
- Sync Out: Turn on or turn off synchronous output.
- OutPut: Select waveform output type, Continuous, single or trun off.
- EXT Trig: Turn on or turn off external trigger, rise edge or fall eage.

Generate the Exponent waveform

To output an Exponent Waveform, please do the following steps:

1. Press F1 button to select the wave "Exp".
 2. Set the Wave Parameters:
 - Frequency: Set the output wave frequency.
 - Amplitude: Set the output wave amplitude.
 - Offset: Set the output wave vertical level offset.
 - Phase: Set the output wave phase.
 - Time: Set the ouput wave Tao param.
 - Exp Type: Set the output wave slope.
- Sync Out: Turn on or turn off synchronous output.
- OutPut: Select waveform output type, Continuous, single or trun off.

EXT Trig: Turn on or turn off external trigger, rise edge or fall eage.

Generate the AM/FM waveform

To output an AM/FM Wave, please do the following Steps:

1. Press F1 button to select "AM/FM Wave".
2. Set the Wave Parameter:
 - Frequency: Set the output wave frequency.
 - Amplitude: Set the output wave amplitude.
 - Offset: Set the output wave vertical level offset.
 - Depth: Set the output wave Depth.
 - Type: Change the output wave "AM" into "FM"
 - Max Freq: Set the output wave Max Frequency.
 - FM: Change the output wave "AM" into "FM".

Sync Out: Turn on or turn off synchronous output.

OutPut: Select waveform output type, Continuous, single or trun off.

EXT Trig: Turn on or turn off external trigger, rise edge or fall eage.

9.2 Edit Arb waveform

User can't edit arbitrary waveform directly under DDS interface for the device. Please use DDS_ARB software to generate a waveform file and load it again.

1. Connect the device to computer by USB. Right click "My Computer-> Device Manger" to install the driver.
2. Please double click "Setup.exe" in DDS_ARB folder and install DDS_ARB software according to installation wizard. After DDS_ARB software installed successfully, you can see DDS_ARB icon on desktop. Double-click the icon, user can select "Wave Parameter - > Arb" to edit arbitrary waveform.

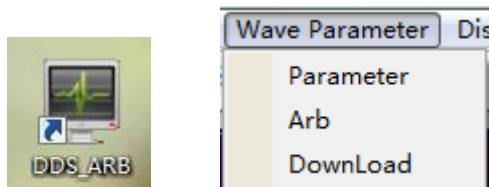

You can download DDS_ARB software from website.

http://www.hantek.com/en/ProductDetail_1_159.html

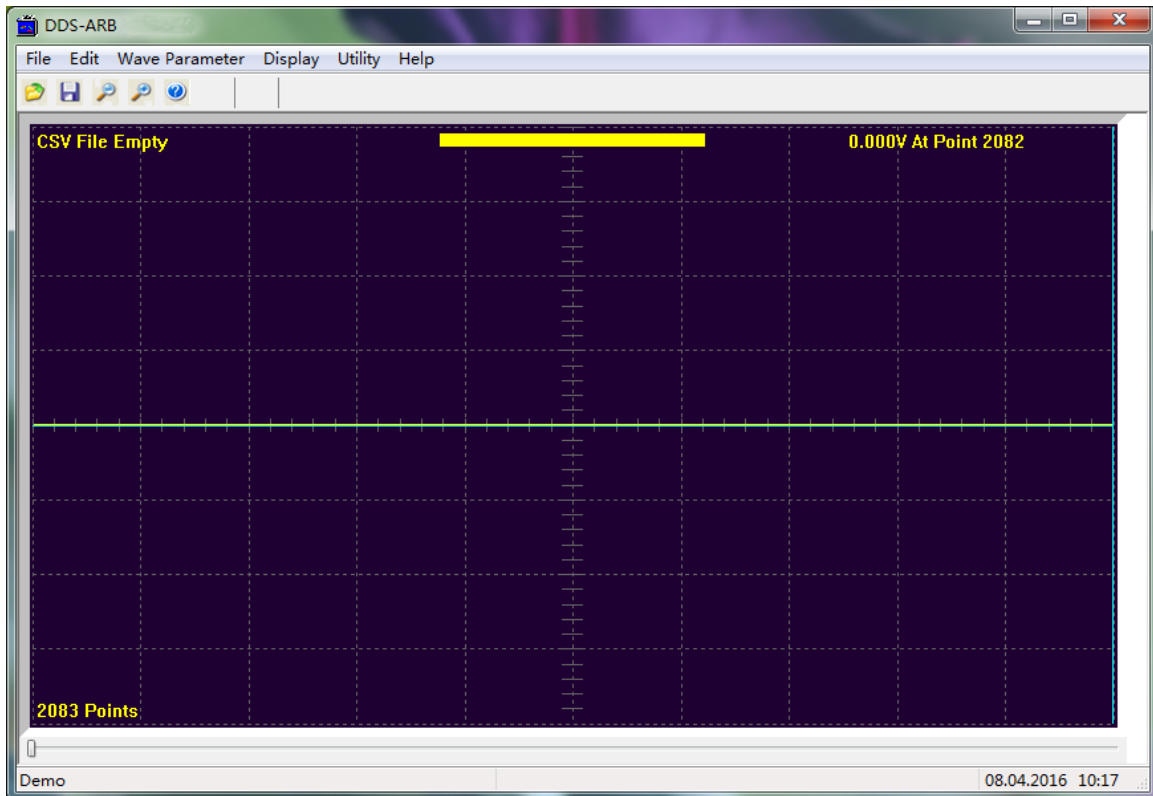

3. Click "Wave Parameter->Parameter" to set waveform frequency.
4. Click "Edit->Points Edit" to set point index and voltage. Also user can drag left mouse to edit points.

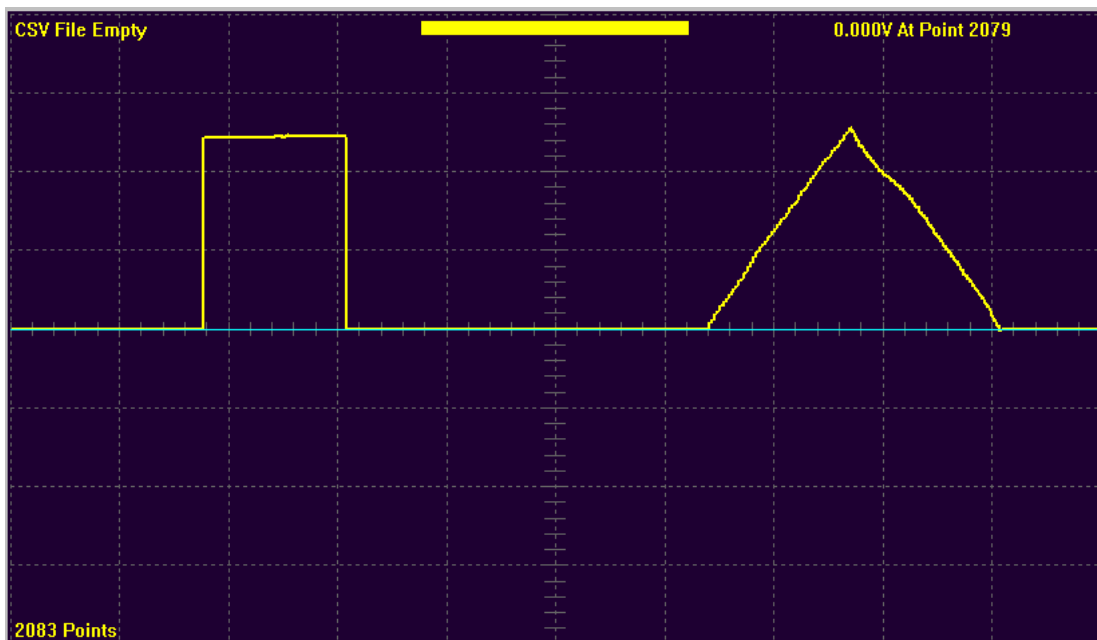

- Click “Wave Parameter ->Download”, use a scope to test the signal output terminal, observe the output waveform figure as follows:

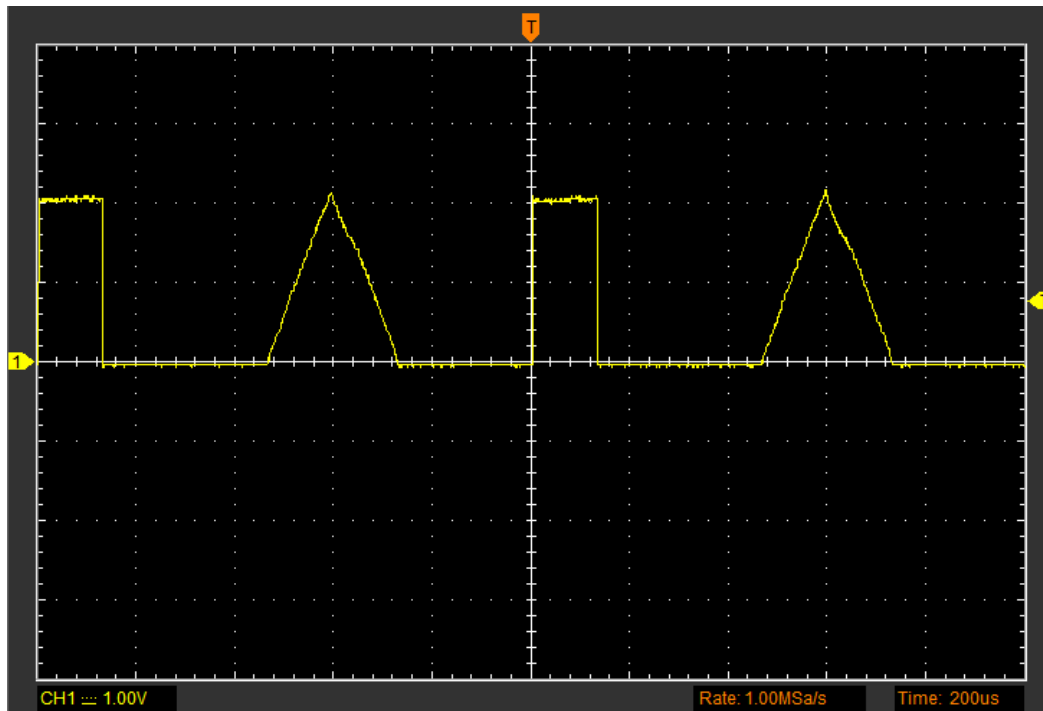

Chapter 10 Troubleshooting

10.1 Problem Settlement

1. If the oscilloscope does not start up at power on, follow these steps:

- 1) Check the power cord to verify it has been connected properly;
- 2) Check the power on/off button to ensure it has been pushed;
- 3) Then restart the oscilloscope.

Contact your local distributor or directly keep touch with our Support department if the oscilloscope still can not be turned on normally.

2. If there is no display of waveforms on the screen when the oscilloscope is turned on, follow these steps:

- 1) Check the probe to assure its proper connection to the input BNC;
- 2) Check the channel switch (such as CH1, CH2 menu buttons) to make sure it has been turned on;
- 3) Check the input signal to verify it has been connected to the probe correctly;
- 4) Affirm that all measured circuits have signals to output;
- 5) Turn up the magnitude for DC signals with large magnitude;
- 6) In addition, you may press the Auto Measure button to perform an automatic detection of signals at first.

Contact our Technical Support department in time if there is still no display of waveforms.

3. If the waveform of the input signal is distorted seriously, follow these steps:

- 1) Check the probe to assure its proper connection to the channel BNC;
- 2) Check the probe to assure its good connection to the measured object;
- 3) Check the probe to verify it has been well calibrated. Otherwise, refer to the content about calibration described in this manual.

4. If the waveform is rolling continuously on the screen but can not be triggered, follow these steps:

- 1) Check the trigger source to make sure it consistent with the input channel;
- 2) Check the trigger level to assure its correct adjustment.
- 3) Check the trigger mode to confirm it is a right choice for the input signal. The default trigger mode is edge trigger. However, it is not suitable for all kinds of input signals.

Chapter 11 Specifications

11.1 Technical Specifications

All specifications herein mentioned apply to the DSO8000E series oscilloscopes. Before checking an oscilloscope to see if it complies with these specifications, make sure it meets the following conditions:

- The oscilloscope must have been operating continuously for twenty minutes under the specified operating temperature.
- The Do Self Cal operation must be performed through the Utility menu if the operating temperature changes by more than 5°C.
- The oscilloscope must be within the factory calibration interval.

All specifications are guaranteed unless noted 'typical'.

Oscilloscope Specifications

Horizontal

Sample Rate Range	1GS/s	
Waveform Interpolation	(sin x)/x	
Record Length	Maximum 2M samples per single-channel; maximum 1M samples per dual-channel (4K, 40K, 512K, 1M optional)	
TIME/DIV Range	DSO8072E DSO8102E	DSO8152E DSO8202E
	4ns/div to 2Ks/div, in a 2, 4, 8 sequence	2ns/div to 2Ks/div, in a 2, 4, 8 sequence
Sample Rate and Delay Time Accuracy	±50ppm over any ≥1ms time interval	
Delta Time Measurement Accuracy (Full Bandwidth)	Single-shot, Normal mode ± (1 sample interval + 100ppm × reading + 0.6ns)	
	>16 averages ± (1 sample interval + 100ppm × reading + 0.4ns)	
	Sample interval = s/div ÷ 200	
Position Range	DSO8072E DSO8102E	
	4ns/div to 8ns/div	(-8div × s/div) to 20ms
	20ns/div to 80µs/div	(-8div × s/div) to 40ms
	200µs/div to 2Ks/div	(-8div × s/div) to 2Ks
	DSO8152E DSO8202E	
	2ns/div to 10ns/div	(-4div × s/div) to 20ms

Vertical

A/D Converter	8-bit resolution, each channel sampled simultaneously			
VOLTS Range	2mV/div to 100V/div at input BNC			
Position Range	$\pm 400\text{V}$ (100V/div-20V/div) $\pm 50\text{V}$ (10V/div-5V/div) $\pm 40\text{V}$ (2V/div-500mV/div) $\pm 2\text{V}$ (200mV/div-50mV/div) $\pm 400\text{mV}$ (20mV/div-2mV/div)			
Selectable Analog Bandwidth Limit, typical	20MHz			
Low Frequency Response (-3db)	$\leq 10\text{Hz}$ at BNC			
Rise Time at BNC, typical	DSO8072E	DSO8102E	DSO8152E	DSO8202E
	<5.0ns	<3.5ns	$\leq 2.3\text{ns}$	<1.8ns
DC Gain Accuracy	$\pm 3\%$ for Normal or Average acquisition mode, 100V/div to 10mV/div $\pm 4\%$ for Normal or Average acquisition mode, 5mV/div to 2mV/div			
DC Measurement Accuracy, Average Acquisition Mode	Measurement Type: Average of ≥ 16 waveforms with vertical position at zero Accuracy: $\pm (3\% \times \text{reading} + 0.1\text{div} + 1\text{mV})$ when 10mV/div or greater is selected			
	Measurement Type: Average of ≥ 16 waveforms with vertical position not at zero Accuracy: $\pm [3\% \times (\text{reading} + \text{vertical position}) + 1\% \text{ of vertical position} + 0.2\text{div}]$ Add 2mV for settings from 2mV/div to 200mV/div; add 50mV for settings from 200mV/div to 5V/div			
Volts Measurement Repeatability, Average Acquisition Mode	Delta volts between any two averages of ≥ 16 waveforms acquired under same setup and ambient conditions			

Note: Bandwidth reduced to 6MHz when using a 1X probe.

Trigger

Trigger Sensitivity (Edge Trigger Type)	Coupling	Sensitivity		
	DC	Source	DSO8072E DSO8102E	DSO8152E DSO8202E
		CH1 CH2	1div from DC to 10MHz; 1.5div from 10MHz to Full	1.5div from 10MHz to 100MHz; 2div from 100MHz to Full

		EXT/5	1V from DC to Full	1V from DC to 100MHz; 1.75V from 100MHz to Full
	AC	Attenuates signals below 10Hz		
	HF Reject	Attenuates signals above 80kHz		
	LF Reject	Same as the DC-coupled limits for frequencies above 150kHz; attenuates signals below 150kHz		
Trigger Level Range	Source	Range		
	CH1, CH2	± 8 divisions from center of screen		
	EXT/5	$\pm 6V$		
Trigger Level Accuracy, typical (Accuracy is for signals having rise and fall times $\geq 20ns$)	Source	Accuracy		
	CH1, CH2	0.2div \times volts/div within ± 4 divisions from center of screen		
	EXT/5	\pm (6% of setting + 200mV)		
Set Level to 50%, typical	Operates with input signals $\geq 50Hz$			

Note: Bandwidth reduced to 6MHz when using a 1X probe.

Video Trigger Type	Source	Range
	CH1, CH2	Peak-to-peak amplitude of 2 divisions
	EXT/5	2V
Signal Formats and Field Rates, Video Trigger Type	Supports NTSC, PAL and SECAM broadcast systems for any field or any line	
Holdoff Range	100ns to 10s	

Pulse Width Trigger

Pulse Width Trigger Mode	Trigger when < (Less than), > (Greater than), = (Equal), or \neq (Not Equal); Positive pulse or Negative pulse
Pulse Width Trigger Point	Equal: The oscilloscope triggers when the trailing edge of the pulse crosses the trigger level. Not Equal: If the pulse is narrower than the specified width, the trigger point is the trailing edge. Otherwise, the oscilloscope triggers when a pulse continues longer than the time specified as the Pulse Width. Less than: The trigger point is the trailing edge. Greater than (also called overtime trigger): The oscilloscope triggers when a pulse continues longer than the time specified as the Pulse Width.
Pulse Width Range	Selectable from 20ns to 10s

Slope Trigger	
Slope Trigger Mode	Trigger when < (Less than), > (Greater than), = (Equal), or ≠ (Not Equal); Positive slope or Negative slope
Slope Trigger Point	<p>Equal: The oscilloscope triggers when the waveform slope is equal to the set slope.</p> <p>Not Equal: The oscilloscope triggers when the waveform slope is not equal to the set slope.</p> <p>Less than: The oscilloscope triggers when the waveform slope is less than the set slope.</p> <p>Greater than: The oscilloscope triggers when the waveform slope is greater than the set slope.</p>
Time Range	Selectable from 20ns to 10s
Overtime Trigger	The leading edge: Rising edge or Falling edge; Time Setting: 20-10s

Alter Trigger	
CH1	Internal Trigger: Edge, Pulse Width, Video, Slope
CH2	Internal Trigger: Edge, Pulse Width, Video, Slope

Trigger Frequency Counter	
Readout Resolution	6 digits
Accuracy (typical)	±30ppm (including all frequency reference errors and ±1 count errors)
Frequency Range	AC coupled, from 4Hz minimum to rated bandwidth
Signal Source	<p>Pulse Width or Edge Trigger modes: all available trigger sources</p> <p>The Frequency Counter measures trigger source at all times, including when the oscilloscope acquisition pauses due to changes in the run status, or acquisition of a single shot event has completed.</p> <p>Pulse Width Trigger mode: The oscilloscope counts pulses of significant magnitude inside the 1s measurement window that qualify as triggerable events, such as narrow pulses in a PWM pulse train if set to < mode and the width is set to a relatively small time.</p> <p>Edge Trigger mode: The oscilloscope counts all edges of sufficient magnitude and correct polarity.</p> <p>Video Trigger mode: The Frequency Counter does not work.</p>

Acquisition

Acquisition Modes	Normal, Peak Detect, and Average	
Single Sequence	Acquisition Mode	Acquisition Stop Time
	Normal, Peak Detect	Upon single acquisition on all channels simultaneously
	Average	After N acquisitions on all channels simultaneously, N can be set to 4, 8, 16, 32, 64 or 128

Inputs

Input Coupling	DC, AC or GND	
Input Impedance, DC coupled	1MΩ±2% in parallel with 20pF±3pF	
Probe Attenuation	1X, 10X	
Supported Probe Attenuation Factors	1X, 10X, 100X, 1000X	
Maximum Input Voltage	Overvoltage Category	Maximum Voltage
	CAT I and CAT II	300V _{RMS} (10×), Installation Category
	CAT III	150V _{RMS} (1×)

Measurements

Cursors	Voltage difference between cursors: ΔV Time difference between cursors: ΔT Reciprocal of ΔT in Hertz ($1/\Delta T$)
Automatic Measurements	Frequency, Period, Mean, Peak-to-peak, Cycle RMS, PRMS, Minimum, Maximum, Rise Time, Fall Time, + Width, - Width, + Duty, - Duty, Base, Top, Middle, Amplitude, Overshoot, Preshoot, Pmean, FOVShoot, RPRESshoot, BWidth, Delay 1-2 ↑, Delay 1-2 ↓, LFF, LFR, LRF, LRR, FFR, EFRF

General Specifications

Display	
Display Type	5.6 Inch width TFT Display
Display Resolution	480 (Vertical) X 640 (Horizontal) pixels
Display Contrast	Adjustable (16 gears) with the progress bar
Probe Compensator Output	
Output Voltage, typical	About 2Vpp into ≥1MΩ load
Frequency, typical	1kHz
Power Supply	
Switching Adatper	AC Input:100-240VAC _{RMS} ,1.5A MAX,50Hz/60Hz; DC Output:12V, 3000mA
Power Consumption	<30W
Environmental	
Temperature	Operating: 32°F to 122°F (0°C to 50°C) Nonoperating: -40°F to 150.8°F (-40°C to +74°C)
Humidity	+104°F or below (+40°C or below): ≤90% relative humidity 40°F to 122°F (-44°C to 50°C): ≤60% relative humidity
Altitude	3,000m (10,000 feet)
Mechanical	
Size	260 x 220 x 75(mm)

Weight	2.5 Kg
--------	--------

Waveform Generator

Frequency Range	1Hz(DC)~25MHz
DAC Clock	2K~200MHz adjustable
Memory Depth	4KSa
Vertical Resolution	12 Bits
Stability	<30ppm
Amplitude	±3.5V Max.
Output Impedance	50 Ω
Output Current	50mA Ipeak=50mA
System Bandwidth	25M
Harmonic Wave Distortion	-50dBc(1KHz), -40dBc(10KHz)

Meter Mode

Maximum Resolution	6000 Counts
DMM Testing Modes	Voltage, Current, Resistance, Capacitance, Diode & Continuity
Maximum Input Voltage	AC: 600V DC: 800V
Maximum Input Current	AC: 10A DC: 10A
Input Impedance	10MΩ

Meter Specification

Range		Accuracy	Resolution
DC Voltage	60.00mV(manual)	±1%±3digit	10uV
	600.0mV		100uV
	6.000V		1mV
	60.00V		10mV
	600.0V		100mV
	800V		1V
AC Voltage	60.00mV(manual)	±1%±3digit	10uV
	600.0mV(manual)		100uV
	6.000V		1mV
	60.00V		10mV
	600.0V		100mV
DC Current	60.00mA	±1%±5digit	10uA
	600.0mA	±1.5%±5digit	100uA
	6.000A		1mA
	10.00A		10mA
AC Current	60.00mA	±1%±5digit	10uA
	600.0mA	±1.5%±5digit	100uA
	6.000A		1mA
	10.00A		10mA

Resistance	600.0	$\pm 1\% \pm 3\text{digit}$	0.1 Ω
	6.000K		1 Ω
	60.00K		10 Ω
	600.0K		100 Ω
	6.000M		1K Ω
	60.00M		10K Ω
Capacitance	40.00nF	$\pm 1\% \pm 5\text{digit}$	10pF
	400.0nF		100pF
	4.000uF		1nF
	40.00uF		10nF
	400.0uF		100nF
	Attention: The smallest capacitance value that can be measured is 5nF.		
Diode	0V~2.0V		
On-off Test	< 10 Ω		

11.2 Accessories

All the following accessories are available by contacting your local HANTEK distributor.

Standard Accessories

- ◆ Two passive probes
- ◆ A Power Adapter
- ◆ A USB cable
- ◆ Two Multimeter Probes
- ◆ A BNC to BNC Cable
- ◆ A Velcro Hanger
- ◆ A Replaceable BNC Head
- ◆ A CD

Chapter 12 General Care and Cleaning

12.1 General Care

Do not put or leave the device in a place where the LCD display will be exposed to direct sunlight for long periods of time.

Note: To avoid damage to the oscilloscope or probes, do not expose them to sprays, liquids, or solvents.

12.2 Cleaning

Examine the oscilloscope and probes as often as operating conditions require. To clean the exterior surface, perform the following steps:

- 1) Use a lint-free cloth to remove floating dust on the outside of the oscilloscope and probes. Take care to avoid scratching the glabrous display filter.
- 2) Use a soft cloth dampened with water to clean the oscilloscope. For more efficient cleaning, you may use an aqueous solution of 75% isopropyl alcohol.

Note: *To avoid damage to the surface of the oscilloscope or probes, do not use any corrosive or chemical cleaning agents.*

Chapter 13 Services and Support

Thank you for choosing HANTEK. Please contact us through the following ways should you have any inquiry regarding our products. We shall do our best to help you.

1. Contact your local HANTEK distributor;
2. Contact your local HANTEK field office;
3. Contact HANTEK headquarters in China.

Headquarters

Qingdao Hantek Electronic Co., Ltd
<http://www.hantek.com>

Address: 5/F, No.177 Zhuzhou Road (Huite Industry City), Qingdao, China
266101

Tel: +86-532-88703687 / 88703697

Fax: +86-532-88705691

Email: service@hantek.com.cn

Technical Support

Email: support@hantek.com.cn
service@hantek.com.cn

Appendix A Harmful and Poisonous Substances or Elements

Component ²	Harmful and poisonous substances or elements ¹					
	Pb	Hg	Cd	Cr(Vi)	PBB	PBDE
Shell and Chassis	X	0	0	X	0	0
Display Module	X	X	0	0	0	0
Circuit Board	X	0	0	X	0	0
Power Supply	X	0	0	X	0	0
Electric Wire and Cable Assembly	X	0	0	0	0	0
Connector	X	0	0	X	0	0
Fastener and Installed Hardware	X	0	X	X	0	0
Other Accessories (including probes)	X	0	0	X	0	0
Others	0	0	0	0	0	0

'X' means that at least the content of this poisonous and harmful substance in a homogeneous material of this component exceeds the limit specified in the SJ/T 11363-2006 standard.

'0' indicates that the content of this poisonous and harmful substance in all homogeneous materials of this component is refrained under the limit stated in the SJ/T 11363-2006 standard.

This component list contains components approved in the file '*Management Measures*'.